

[www.italiastar.ro](http://www.italiastar.ro)



## Listă de prețuri 2024 DISTRIBUȚIE

Utilaje și echipamente  
pentru construcții



Valabil incepand cu:  
06.05.2024

# Cuprins

## IMER & MARUZEN



**Betoniere profesionale**  
Pagina 05



**Betoniere semi-automate**  
Pagina 06



**Pompa multifunctionala SMALL 50**  
Pagina 07



**Electropalane**  
Pagina 09



**Malaxoare planetare si continue**  
Pagina 11



**Circulare pentru lemn**  
Pagina 12



**Masini pentru taiat gresie si faianta**  
Pagina 13



**Masina pentru taiat caramida, piatra naturala si tigla**  
Pagina 14



**Sisteme pentru vibrare beton**  
Pagina 15



**Elicoptere pardoseala**  
Pagina 16



**Grup hidraulic si accesorii**  
Pagina 17

## BISONTE CONSTRUCTII



**Compactare**  
Pagina 19



**Masini de taiat asfalt/beton**  
Pagina 22



**Masini de taiat caramida/BCA/metale ghilotina pavele**  
Pagina 23



**Discuri diamantate segmentate**  
Pagina 24



**Masini de taiat gresie/faianta Ghilotina**  
Pagina 25



**Elicoptere pentru slefuit si finisat pardoseli**  
Pagina 26



**Sisteme vibrare beton**  
Pagina 27



**Pompe pentru gleturi | tencuit**  
Pagina 28



**Pompe airless zugravit | vopsit**  
Pagina 32



**Slefuire pereti | tavan Aspiratoare si malaxoare**  
Pagina 37



**Compressoare electrice**  
Pagina 39



**Aparate de sudura Taiere cu plasma**  
Pagina 41



**Scari profesionale si universale**  
Pagina 43



**Betoniere Roabe**  
Pagina 45



**Masini de carotat**  
Pagina 46



**Generatoare open**  
Pagina 47

## BISONTE AGRO



**Motocultoare**  
Pagina 49



**Masini multifunctionale**  
Pagina 52



**Remorci pentru motocultoare**  
Pagina 54



**Motoburghie**  
Pagina 54



**Trenchere (sapare santuri)**  
Pagina 54



**Motopompe si furtunuri absorbtie**  
Pagina 55



**Masini si tractoare de tuns iarba**  
Pagina 57



**Atomizoare**  
Pagina 58



**Aparate de spalat cu presiune**  
Pagina 58



**Despicatoare lemne**  
Pagina 59



**Tocatoare crengi**  
Pagina 59

# Cuprins

## SISTEME DE POMPARE



**Pompe airless cu membrana pentru zugravit**  
Pagina 61



**Pompe airless cu membrana pentru vopsit**  
Pagina 63



**Pompe airless cu piston pentru zugravit**  
Pagina 65



**Pompe airless hidraulice pentru gleturi**  
Pagina 68



**Pompe airless cu membrana pentru hidroizolatii si injectari**  
Pagina 69



**Pompe pentru gleturi | tencuieli | decorative**  
Pagina 70

## ECHIPAMENTE PENTRU FINISARE



**Echipamente pentru finisare gips carton**  
Pagina 72



**Echipamente pentru slefuit, raschetat, polisat**  
Pagina 73

## SCHELE | COFRAJE | PANOURI

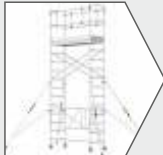

**Schela mobila profesionala Protube**  
Pagina 77



**Scari si schele profesionale**  
Pagina 81

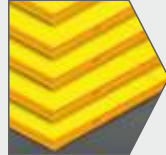

**Panou galben**  
Pagina 84



**Panou TEGO**  
Pagina 85



**Grinda H20**  
Pagina 86



**Accesorii pentru cofraje**  
Pagina 87



**Accesorii pentru cofraje**  
Pagina 88



**Popi metalici si trepiezi**  
Pagina 92

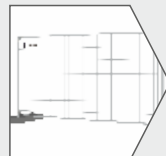

**Sistem mobil EU2 Garduri**  
Pagina 93



**Tubulatura evacuare deseuri | Parapeti rutieri**  
Pagina 94

## GENERATOARE DE CURENT



**Generatoare de curent seria Lite**  
Pagina 96



**Generatoare de curent seria Top**  
Pagina 97



**Generatoare de curent seria EVO**  
Pagina 99



**Generatoare tip inverter - COVER**  
Pagina 100



**Generatoare tip inverter - OPEN**  
Pagina 100



**Generatoare pentru sudura**  
Pagina 101



**Generatoare de curent rezidentiale**  
Pagina 102



**Generatoare de curent rezidentiale**  
Pagina 103



**Motopompe**  
Pagina 104



**Pompe submersibile electrice**  
Pagina 105



**Motopompe ape curate/murdare**  
Pagina 106



**Aparataj electric**  
Pagina 108

## ECHIPAMENTE PENTRU TAIERE GRESIE | FAIANTA



**Masini manuale de taiat gresie | faianta**  
Pagina 111



**Masini electrice de taiat gresie | faianta**  
Pagina 113



**Echipamente diverse pentru taiere/finisare si ventuze ridicare**  
Pagina 114

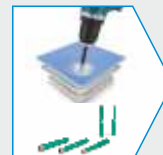

**Freze, caroate si accesorii**  
Pagina 115



**Discuri diamantate**  
Pagina 116

# IMER & MARUZEN



**Betoniere profesionale**  
Pagina 05



**Betoniere semi-automate**  
Pagina 06



**Pompa multifunctionala SMALL 50**  
Pagina 07



**Electropalane**  
Pagina 09



**Malaxoare planetare si continue**  
Pagina 11



**Circulare pentru lemn**  
Pagina 12



**Masini pentru taiat gresie si faianta**  
Pagina 13



**Masina pentru taiat caramida, piatra naturala si tigla**  
Pagina 14



**Sisteme pentru vibrare beton**  
Pagina 15



**Elicoptere pardoseala**  
Pagina 16



**Grup hidraulic si accesorii**  
Pagina 17



Cod produs	Descriere produs	Pret Euro (fara TVA)
<b>Minibeta</b>		
8033679000332	<b>Minibeta 130</b> motor monofazat 2P 230V 50 Hz 0,3 kW	578
8033679000349	<b>Minibeta 130 2P</b> motor monofazat 0,3 kW - cuva plastic HDPE	699
<b>Rollbeta</b>		
8033679000103	<b>Rollbeta 130</b> motor monofazat 2P 230V 50 Hz 0,3 kW	647
8033679003012	<b>Rollbeta 130</b> motor monofazat 2P 230V 50 Hz 0,37 kW - cuva plastic HDPE	717
8033679000110	<b>Rollbeta 130</b> cu motor benzina	1.342
IM1105490	Suport rotativ	199
IM1188810	Bena plastic HDPE pentru Rollbeta/Syntesi 140	261
8033679027902	<b>Riobeta 130</b> motor monofazat 230V - 0,3 kW	672
<b>Syntesi</b>		
8033679000141	<b>Syntesi 140</b> motor monofazat 230V 50 Hz 0,3 kW	767
8033679000158	<b>Syntesi 140</b> motor monofazat 230V 50 Hz 0,3 kW cuva plastic HDPE	892
8033679017903	<b>Syntesi 160</b> cu motor monofazat 230V-50Hz 0,3 kW	836
8033679000165	<b>Syntesi 190</b> cu motor monofazat 230V-50Hz 1 kW	1.164
8033679000202	<b>Syntesi 250</b> cu motor monofazat 230V-50Hz 1 kW	1.345
8033679000219	<b>Syntesi 250</b> cu motor benzina Worms EX170, 5,6 cp	2.541
8033679002701	<b>Syntesi 300</b> cu motor monofazat 230V-50Hz 1,4 kW	1.632
8033679000264	<b>Syntesi 350</b> cu motor monofazat 230V-50Hz 1,4 kW	1.560
8033679004842	<b>Syntesi 350</b> cu motor benzina Honda, 5,4 cp	3.000
IM1105804	<b>Syntesi 350</b> cu motor Yanmar diesel, 7,7 cp	la cerere
IM3209650	Curea distributie Syntesi 140-160	10,5
IM3208791	Curea distributie Syntesi 190-250	18,3
IM3235727	Curea distributie Syntesi 300-350	19,7
IM3209809	Roata pentru Syntesi 140 sau 160	7,1
IM2211100	Roata pentru Syntesi 190 dim. 300x60 mm	15,4
IM2211200	Roata pentru Syntesi 250 dim. 370x70 mm	25,0
IM2211250	Roata pentru Syntesi 300 sau 350 dim. 385x90 mm	30,7
3161304182384	<b>Clean Syntesi</b> Acid mineral destinat curatarii betonierelor interior/exterior 0,5L	10,8
3161304182377	<b>Clean Syntesi</b> Acid mineral destinat curatarii betonierelor interior/exterior 1L	21,5
<b>Syntesi R - remorcabile in santier (neomologabile rutier)</b>		
8033679000189	<b>Syntesi 190 R</b> cu motor monofazat 240V-50Hz, 1 kW	1.447
8033679000196	<b>Syntesi 190R</b> cu motor benzina Honda, 3,9 cp	2.238
8033679020408	<b>Syntesi 250 R omologabil</b> cu motor monofazat 230V-50Hz 1 kW	2.297
8033679020422	<b>Syntesi 250 R omologabil</b> cu motor benzina Honda 3,9 cp	3.502
8033679020446	<b>Syntesi 350 R omologabil</b> cu motor monofazat 230V-50Hz 1,4 kW	2.561
8033679020460	<b>Syntesi 350 R omologabil</b> cu motor benzina Honda 5,4 cp	3.601
IM1105831	<b>Syntesi 350 R omologabil</b> cu motor diesel Yanmar 5,4 cp	la cerere



Cod produs	Descriere produs	Pret Euro (fara TVA)
SI1007651	<b>BIR 330 / ID motor electric</b> 3 kW, capacitate cuva brut 330 l productivitate 6,5 m <sup>3</sup> /h, greutate echipament 900 kg	8.108
SI1007652	<b>BIR 330 / ID Kohler diesel</b> 7,5 cp, demaraj electric, capacitate cuva brut 300 l, productivitate 6,5 m <sup>3</sup> /h, greutate 900 kg	la cerere
SI1007067	<b>BIR 400 / ID electric</b> 3 kW, capacitate cuva brut 400 l productivitate 8m <sup>3</sup> /h, greutate echipament 950 kg	8.433
SI1007653	<b>BIR 400 / ID Hatz diesel A/E</b> 9,5 cp, demaraj electric capacitate cuva brut 400 l, productivitate 8m <sup>3</sup> /h, greutate 950 kg	la cerere
SI1007654	<b>BIR 500 / ID electric</b> 4,1 kW, capacitate cuva brut 500 l productivitate 12 m <sup>3</sup> /h, greutate echipament 1.540 kg	11.490
SI1007655	<b>BIR 500 / ID Kohler diesel A/E</b> 28,5 cp, demaraj electric, capacitate cuva brut 500 l, productivitate 12m <sup>3</sup> /h greutate 1.540 kg	la cerere
SI1007137	<b>BIR 750 / ID electric</b> 5,6 kW, capacitate cuva brut 750 l, productivitate 17 m <sup>3</sup> /h, greutate echipament 1.700 kg	14.386
SI1007656	<b>BIR 750 / ID Kohler diesel A/E</b> 28,5 cp, demaraj electric, capacitate cuva brut 750 l, productivitate 17 m <sup>3</sup> /h greutate 1.700 kg	la cerere
SI1006522	<b>BIR 1000 / ID electric</b> 7,5 kW, capacitate cuva brut 1.000 l, productivitate 18 m <sup>3</sup> /h, greutate echipament 1.800 kg	16.428
SI1007657	<b>BIR 1000 / ID Hatz diesel A/E</b> 34,5 cp, demaraj electric, capacitate cuva brut 1.000 l, productivitate 18 m <sup>3</sup> /h, greutate 1.800 kg	la cerere
SI1007658	<b>BIR 1500 / ID electric</b> 15 kW, capacitate cuva brut 1.500 l, productivitate 22 m <sup>3</sup> /h, greutate echipament 2.400 kg	23.444
SI1007659	<b>BIR 1500 / ID Hatz diesel A/E</b> 34,5 cp, demaraj electric capacitate cuva brut 1.500 l, productivitate 22 m <sup>3</sup> /h, greutate 2.600 kg	la cerere
Accesorii		
BIRLTE	Lopata tarsietoare pentru incarcare paleta pentru betoniere motor termic	2.197
BIRLTT	Lopata tarsietoare pentru incarcare paleta pentru betoniere motor electric	1.704
BIRCLIT	Contor apa	863
BIRBILIT	Cantar electronic	2.060
BIR4WIT	Sistem cu 4 roti, doar pentru BIR 500/700/1.000	811
VIBRIT	Vibrator	763



Cod produs	Descriere produs	Pret Euro (fara TVA)
------------	------------------	----------------------

8033679032715	<b>Small 50 EVO pompa cu snec, versiune standard fara accesorii</b>	4.534
---------------	---	-------

Debit material 0,8-14 l/min., granulometrie max. 6 mm,  
Echipament multifunctional care se utilizeaza cu unul din urmatoarele kit-uri:

### Kit pentru tencuiala traditionala sau preamestecata

8033679002220	Sita vibranta 230V 50 Hz	1.858
---------------	--------------------------	-------

8033679002213	Compresor cu membrana 230V 50Hz	1.499
---------------	---------------------------------	-------

IM1107005	Kit compus din:	495
-----------	-----------------	-----

Lance aplicare mortare traditionale sau preamestec  
15 m furtun pentru material Ø 25 mm cuplari rapide  
16 m furtun aer Ø 13 mm cu cuplari Geka  
Lance curatire si burete Ø 30 mm  
Deflector Ø 10 - 14 mm pentru mortar preamestec  
Deflector Ø 12 mm pentru mortar traditional



### Kit pentru gleturi

8033679002213	Compresor cu membrana 230V 50Hz	1.499
---------------	---------------------------------	-------

IM1107005	Kit compus din:	495
-----------	-----------------	-----

Lance aplicare mortare traditionale sau preamestec  
15 m furtun pentru material Ø 25 mm cuplari rapide  
16 m furtun aer Ø 13 mm cu cuplari Geka  
Lance curatire si burete Ø 30 mm  
Deflector Ø 10 - 14 mm pentru mortar preamestec  
Deflector Ø 12 mm pentru mortar traditional



1107543  
Compresor  
cu membrana

### Kit pentru injectare mortare

8033679002220	Sita vibranta 230V 50 Hz	834
---------------	--------------------------	-----

IM1108005	Kit compus din:	1.509
-----------	-----------------	-------

Lance pentru injectare, chituire rosturi, vopsire  
Manometru si comutator de presiune  
5+10 m furtun pentru material Ø 25 mm cuplari rapide  
Lance curatire si burete Ø 30 mm  
Deflector cu conector furtun Ø 16 mm



1107510  
Sita vibranta

### Kit pentru zugraveli decorative

8033679002220	Sita vibranta 230V 50 Hz	834
---------------	--------------------------	-----

8033679024314	Compresor cu piston 230V 50Hz	1.760
---------------	-------------------------------	-------

IM1107009	Kit compus din:	682
-----------	-----------------	-----

Lance pentru vopsire cu deflector Ø 5 - Ø 6 mm  
Reductie pentru furtun de la Ø 25 la Ø 19  
10 m furtun material Ø 19 mm cuplari rapide  
16 m furtun aer Ø 13 mm cu cuplari Geka  
Lance curatire si burete Ø 23 mm



### Kit pentru chituire rosturi

IM1107010	Kit compus din:	803
-----------	-----------------	-----

Lance pentru curatire (sablare), injectare, chituire rosturi, vopsire  
Deflector Ø5 - Ø6 - Ø8 - Ø12 mm  
Deflector cu conector furtun Ø 16 mm  
10+5 m furtun material Ø 25 mm cu cuplari rapide  
16 m furtun aer Ø 13 mm cu cuplari Geka



IM1106052 **Small S50 Airless** Pompa cu snec de inalta presiune pentru aplicare airless 7.980

Debit material: 8,5 l/min.; presiune 0 - 120 bar (nu necesita compresor)  
 Putere instalata 2,2 kW - 230V; amperaj 9,5 A  
 Lungime pompare 30 m; capacitate bena 50 l  
 Greutate echipament 70 kg; dimensiuni 1.336x504x682 mm  
 Echipare standard: pistol AG19, kit duze, kit curatare pistol si duze, filtru alb si verde, 20m furtun airless 1/2"; manometru, rotor si stator 4N 13S 120bar, comanda electrica cablu 15m ; cablu electric 20m, trusa de scule integrata



IM1107540 Lance aplicare mortar preamestec cu deflector Ø 14 134

IM1107011 Lance pentru injectare, chituire rosturi, vopsire 391

IM1107549 Prelungitor lance, lungime 1,43 m 147

8033679002220 **Sita vibranta 230V / 50 Hz** 834

IM1107662 Manometru 217

IM1107515 Kit masura reglaj - control presiune, pentru injectari 527

IM1107513 Capac pentru cuva 192

8033679002213 **Compresor cu membrana 230V / 50Hz 250 l/min.** 1.499

8033679024314 Compresor cu piston 400l/min. 230V / 50Hz 1.760

IM1108009 16 m extensie la comanda electrica prin cablu 158

IM1108008 16 m comanda electrica prin cablu 135

IM1107525 15 m furtun material Ø 25 mm cu cuplari rapide 273

IM1107526 10 m furtun material Ø 25 mm cu cuplari rapide 228

IM1107527 5 m furtun material Ø 25 cu cuplari rapide 186

IM1107529 10 m furtun material Ø 19 mm cu cuplari rapide 212

IM1107530 5 m furtun aer Ø 13 mm cu cuplari Geka 30,8

IM1107531 10 m furtun aer Ø 13 mm cu cuplari Geka 49,6

IM1107532 16 m furtun aer Ø 13 mm cu cuplari Geka 65,0

IM1107570 Cuplaj tip profil "U" de otel pt furtun Ø 25 85,1

IM1107030 Stator D 8-1.5 Verde cu strangere 84,6

IM1107031 Rotor D 8-1.5 Verde 86,3

IM1107032 Stator D4 - 1/2 Verde deschis cu strangere 103

IM1107033 Rotor D4 86,3

### Deflectori pentru chituire, vopsire

IM1107561 3-buc Deflectori Ø 5 mm otel 71,3

IM1107562 3-buc Deflectori Ø 6 mm otel 71,3

IM1107563 3-buc Deflectori Ø 8 mm otel 71,3

IM1107564 3-buc Deflectori Ø 12 mm otel 71,3

### Deflector pentru injectare si netezire fara compresor

IM1107567 Kit cu 1 deflector + 5 conectori furtun Ø 16 mm + 5 conectori furtun Ø 13 mm 62,5





Cod produs

Descriere produs

Pret Euro (fara TVA)

8033679019303	<b>ES 150N cu cadru fix si morsete ancorare schela</b> Sarcina 150 Kg - lungime cablu 30m, monofazat 230V-50Hz Comanda 3 butoane, cablu 1 m	866
8033679002411	<b>ET 200 N cu cadru fix, lungime cablu 30m</b> Sarcina 200 Kg monofazat 230V-50Hz, comanda 3 butoane cablu 1 m	889
8033679004903	<b>ETR 200 N cu cadru extensibil, lungime cablu 30m</b> Sarcina 200 Kg monofazat 230V-50Hz comanda 3 butoane cablu 1,5 m	956
8033679002008	<b>TR 225 N cu cadru extensibil, lungime cablu 30m, nu include comanda</b> Sarcina 200 Kg - monofazat 230V-50Hz	1.051
IM1191008	Comanda 3 butoane pe cablu la 1,5 m	143
IM1191007	Comanda 3 butoane pe cablu la 5 m	201
IM1191032	Comanda 3 butoane tensiune joasa 30 m	875
8033679019310	<b>ET 150 N cu cadru extensibil, lungime cablu 40m viteza 30 m/min.</b> Sarcina 150 Kg monofazic 230V-50Hz comanda 3 butoane cablu 1,5 m	1.187
8033679030605	<b>TRVK 200 N lungime cablu 51 m, viteza de ridicare 30 m/min.</b> Sarcina max. 200 kg, monofazic 230V-50Hz comanda cablu 1,5 m	1.284
IM1191033	Prelungitor 50 m pentru comanda BT 24V	931
8033679004910	<b>AIRONE 200 N cu brat extensibil, lungime cablu 30m</b> Sarcina 200 Kg monofazic 230V-50Hz comanda cablu 1 m	1.006
8033679019907	<b>AIRONE 300 NEW cu brat extensibil, lungime cablu 30m</b> Sarcina 300 kg, monofazic 230V-50Hz, comanda 3 butoane, cabul 1,5 m	1.109
8033679020507	<b>ET 300N, fara suport, lungime cablu 30m</b> Sarcina 300 Kg monofazic 230V-50Hz comanda 3 butoane, cablu 1,5 m	1.103
8033679022501	<b>G 500 fara suport, lungime cablu 42m</b> Sarcina 500 Kg, monofazic 230V-50Hz, comanda 3 butoane 1,5 m	1.652
8033679022105	<b>AP 150 - Electropalan pentru ridicare / montare schela</b> Sarcina 150 kg, monofazic 230V-50 Hz, comanda 3 butoane 5 m, 81m cablu, poate ridica la 40 m inaltime, include pioner cu scripete	1.726



Cod produs	Descriere produs	Pret Euro (fara TVA)
<b>Suporti ancorare pentru toate electropalanele Imer, pentru ET300 si G500</b>		
IM1191230	Suport prindere universala de max. 300Kg, fara containere contra greutate si protectia pentru picioare	921
IM1191240	Suport prindere universala de max. 500Kg, fara containere contra greutate si protectia pentru picioare	983
IM1199210	Container contragreutate 150 Kg, 1buc	288
IM1199220	Container contragreutate 250 Kg, 1buc	320
IM1199230	Lamela de protectie la partea inferioara	74,3
IM1191247	Legaturi la partea inferioara intre suportul din fata si cel din spate	51,7
IM1199215	Frana de siguranta electropalan 500kg	127
IM1199221	Container contragreutate 500 kg (1 buc.)	545
<b>Stalpi de ancoraj pana la 200kg</b>		
8033679001148	Stalp reglabil pe inaltime de la 2,45 la 3,3m pentru interior - se foloseste singur sau cu 1199134	380
IM1199134	Kit brate+container pentru ancorare stalp - se foloseste cu 1199102	494
IM1199105	Stalp de ancoraj pentru lateral fereastr	533
8033679001223	<b>Suport universal electropalan cu prindere de schela</b>	182
IM1190180	Suport electropalan cu prindere de schela pentru AP60, AP120 si Ap150	164
<b>Stalp de ancoraj pentru AIRONE 300</b>		
8033679001179	Stalp pentru AIRONE 300 fara container de contra greutate	642
IM1199122	Container contragreutati pentru AIRONE 300	479
<b>Bandiere (distantiere)</b>		
8033679001209	Bandiera pentru stalpi	181
IM1199155	Bandiera pentru morsete	101
<b>Morsete pentru ancoraj</b>		
IM1199107	Morsete pentru ancoraj, sarcina max. 200 Kg	80,8
<b>Bene rabatabile pentru materiale</b>		
IM1191280	Bena trapezoidala de 45L	200
8033679000677	Bena trapezoidala de 90L	231
8033679000684	Bena trapezoidala de 120L	276
TEE001TV	Recipient dreptunghiular din PPR Teknolast cu manere, capacitate 180 l	98
TEE001BB	Bena basculanta polietilena 70L/150 kg	94
<b>Port-galeti</b>		
8033679000578	Port-galeti pentru 2 buc.	99,0
8033679000561	Port-galeti pentru 4 buc.	151
IM1190905	<b>Ancora de ridicare materiale</b>	
	Suport de ridicare cu 3 carabine	138
IM1191041	<b>Carucior pentru utilizare cu suport universal</b>	
	Carucior cu frana pentru electropalane seria ES-ET-ETR	169
BA1005404	<b>Roaba pentru ridicare materiale cu electropalanul (brat rabatabil)</b>	75
	Capacitate 80 l, manere rabatabile	
	Manere tubulare de 30 mm, tabla de 0,8 mm	
	Roata pneumatica 330 mm	
	Greutate 14 kg	

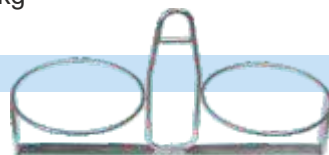
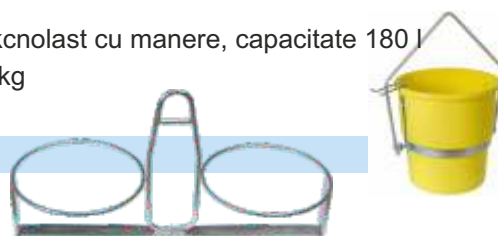

Cod produs	Descriere produs	Pret Euro (fara TVA)
8033679001025	<b>MIX 60</b> cu motor monofazat 230V-50Hz putere 0,55 kW cu 2 rezervoare si paleta standard, capacitate cuva brut 56 l, diametru cuva 580 mm	765
IM1193965	Paleta pentru mixare adezivi speciali / fluide	85,3
IM1193968	Kit 5 rezervoare pentru MIX 60/MIX ALL	187
8033679029203	<b>Mix All</b> cu motor monofazic 230V-50Hz, putere 0,55 kW Noul tip de pale cu rotire in 3 axe Capacitate cuva 56 l, diametru cuva 580 mm Include 2 rezervoare si paleta in 3 axe	820
IM1193968	Kit 5 rezervoare pentru MIX 60/MIX ALL	187
8033679030001	<b>Mix 80</b> cu motor monofazic 230V - 50 Hz, 1,1 kW Capacitate cuva brut 80 l, diametru cuva incarcare 608 mm	1.856
IM1107635	Paleta mixare din cauciuc pentru MIX 80	63,6
8033679001049	<b>Mix 120 Plus</b> cu motor monofazat 230V-50Hz, putere motor 1,4 kW Capacitate cuva brut 120 l, diametru cuva 745 mm	2.351
IM1107618	Kit lamele cauciuc pentru pale	71,8
<b>Doar pentru materiale cu malaxare rapida</b>		
<b>Malaxor continuu SPIN</b>		
8033679001612	<b>Spin 15 A</b> motor 230V - 1,4 kW debit material 15 l/min., capacitate cuva 60 l Include pompa de apa	1.950
IM1107601	Kit debitmetru apa	268
8033679035518	<b>Spin 15 A-Z Clean</b> Idem. Camera amestecare cu autocuratare din cauciuc elastomer.	2.070
8033679028909	<b>Spin 30 Plus</b> motor 400V - 3 kW debit material 30 l/min. capacitate cuva 110l	3.780
8033679028916	<b>Spin 30 Plus</b> motor 230V - 2,2 kW debit material 30 l/min. capacitate cuva 110l Include pompa de apa	3.830
IM1107514	Kit debitmetru apa	274



Cod produs

Descriere produs

Pret Euro  
(fara TVA)

## Circular pentru lemn H 110PLUS VF disc Ø350 mm Widia

Complet echipat dreptar, impingator si plan de lucru rabatabil

IM1188490 H 110VF PLUS cu motor monofazic 2,5 kW

1.010

IM1188491 H 110VF PLUS cu motor trifazic 3 kW

1.010

## Circular pentru lemn H 110PLUS VR disc Ø350 mm Widia, inaltime reglabila de taiere

Complet echipat - dreptar, impingator, plan de lucru rabatabil

8033679036409 H 110VR PLUS cu motor monofazic 2,5 kW

1.027

8033679037222 H 110VR PLUS cu motor trifazic 3 kW

1.027

IM1187635 Kit roti pentru H 110

67,9

## Discuri de taiat material lemnos

IM1193964 Widia Ø 300 mm x 3,2 Z = 48

97,6

IM1193960 Widia Ø 350 mm x 3,2 Z = 54

109

IM1193790 Widia Ø 315 mm x 3,2 Z = 28 (cu limitator pentru H110)

65,1

IM1193791 Widia Ø 350 mm H110 PLUS

67,8



Plan de lucru rabatabil inclus



Cod produs	Descriere produs	Pret Euro (fara TVA)
------------	------------------	----------------------

### Combi 200 VA cu disc si suport

8033679000370	Masina de taiat, cu disc inclus, diam. 200 mm, motor 230V / 50 Hz 1,5 kW Lungime taiere 500 mm, adancime max. de taiere 55 mm	989
IM1188086	Plan de taiere suplimentar pentru Combi 200 VA	123
IM1193848	Disc Ø 200 mm ceramica - coroana continua	39,3
IM1193781	Disc Ø 200 mm <b>Premium</b> pentru gresie portelanata - coroana continua	85,3

### Combi 250 VA cu disc si suport

8033679000387	Masina de taiat, cu disc inclus, diam. 250 mm, motor 230V-50Hz, 1,5 kW	1.095
IM1188166	Plan de taiere suplimentar pentru Combi 250 VA	138

### Combi 250-1000 cu disc, suport si laser

8033679000400	Masina de taiat, cu disc inclus, diam. 250 mm, motor 230V-50Hz, 1,5 kW Lungime max. de taiere 1.100 mm, adancime max. taiere 105 mm	1.693
IM1188177	Plan de taiere suplimentar pentru Combi 250-1000	171
IM1188178	Dispozitiv imobilizare materiale pentru 200, 250 si 250-1000	44,2

### Combi 250-1500 cu disc, suport si laser

8033679026707	Masina de taiat, cu disc inclus, diam. 250 mm, motor 1,5 kW Lungime max. taiere 1.530 mm, adancime max. taiere 105 mm	2.171
IM1188179	Plan de taiere suplimentar pentru Combi 250-1500	183

### Discuri compatibile cu masinile Combi 250, 250-1000, 250-1500

IM1193852	Disc Ø 250 mm - ceramica - coroana continua	56,1
IM1193801	Disc Ø 250 mm caramida /tigla - coroana sectionata	75,2
IM1193804	Disc Ø 250 mm <b>Premium</b> pentru granit - coroana sectionata	109
IM1193783	Disc Ø 250 mm <b>Premium</b> pentru gresie portelanata - coroana continua	111

### C350 iPower

8033679018603	Masina de taiat 230V 50 Hz, 2,5 kW cu disc inclus - diam. 350mm Lungime max. 1.200mm, adancime max. taiere 120 mm, trasator laser si roti	2.462
IM1193856	Disc Ø 350 mm ceramica - coroana continua	112
IM1193785	Disc Ø 350 mm <b>Premium</b> pentru gresie portelanata - coroana continua	134
IM1193824	Disc Ø 350 mm <b>Premium</b> pentru granit - coroana sectionata	165
IM1193894	Disc Ø 350 mm caramida / tigla - coroana sectionata, laser	106
IM3233271	Pompa apa masini de taiat Imer Combi / Masonry	76,1
IM1188157	Sistem de blocare placi Combi VA – blocati plăcile și utilizați laserul masinii pentru o taiere precisă.	201



Cod produs	Descriere produs	Pret Euro (fara TVA)
<b>M 400 SMART disc 400mm inclus</b>		
8033679012908	M400 Smart 350/400mm, motor monofazic 2,2 kW, 230V-50Hz 2 roti pentru transport	1.552
IM1187640	Suport de taiere la 45°	107
IM1193908	Disc Ø 400 mm <b>Premium</b> pentru Granit / Piatra Naturala - coroana sectionata	143
IM1193824	Disc Ø 350 mm <b>Premium</b> Granit / piatra naturala - coroana sect. - s. laser	165
IM1193894	Disc Ø 350 mm caramida/tigla - coroana sectionata - s. laser	106
<b>Masonry 600 (fara disc)</b>		
8033679033903	Motor 4 kW, 400V/50Hz Diametru disc 600 mm, lungime max. taiere 750 mm (disc ridicat) Lungime max. taiere 460 mm (placi inaltime 200 mm) Adancime taiere 1 / 2 treceri: 215 / 300 mm 2 roti pentru transport	2.289
IM1193926	Disc Ø 600 mm <b>Premium</b> Granit / Piatra Naturala - coroana sectionata	431
<b>Masonry 750 Plus (fara disc)</b>		
8033679030100	Masonry 750 Plus motor 5,5 kW, 400V/50Hz	3.632
8033679030117	Masonry 750 Plus motor 2,2 kW, 230V/50Hz Diametru disc 750 mm, lungime max. taiere 560 mm Adancime max. taiere 300 mm 4 roti din care 2 directionale cu frana pentru transport	3.632
IM1193939	Disc Ø 700 mm granit / marmura / piatra naturala	621
IM1193913	Disc Ø 750 mm <b>Premium</b> pentru caramida / tigla	664
IM1193941	Disc Ø 750 mm <b>Premium</b> pentru granit / marmura / piatra naturala	721
IM1169275	Protectii laterale pentru disc	79,7
IM1188870	Suport de taiere la 45°	92,6
IM1187622	Ghidaj taiere reglabil	154
IM3233271	Pompa apa masini de taiat Imer Combi / Masonry	76,1
E001TV	Recipient dreptunghiular din PPR Teknoplust cu manere, capacitate 180 l	98



Cod produs	Descriere produs	Pret Euro (fara TVA)
------------	------------------	----------------------

IM0002000	<b>Vibrator electric seria FX2000</b> , 2 kW, 230V, 12.000 rpm (nu include lance)	234
-----------	---	-----



### Lance si cap vibrant pentru seria FX2000

IM0003003	Diametru Ø 30mm, 3 m lungime	168
IM0003803	Diametru Ø 38mm, 3 m lungime	174
IM0003404	Diametru Ø 34mm, 4 m lungime	186
IM0003804	Diametru Ø 38mm, 4 m lungime	190
IM0004304	Diametru Ø 43mm, 4 m lungime	205
IM0005004	Diametru Ø 50mm, 4 m lungime	207

### Convertizor de inalta frecventa seria NW (nu include lance)

IM0000586	<b>NW 0586</b> Convertizor 2kVA - 400V, 28A, functioneaza cu 2 lancei Ø 38/50mm sau 1 lance Ø60mm	718
IM0000600	<b>NW 0600</b> Convertizor 3 kVA - 400V, 42A, functioneaza cu 3 lancei Ø 38/50mm sau 2 lancei Ø60/70mm	1.022



### Convertizor de inalta frecventa seria ST (nu include lance)

IM0000482	<b>ST 0482</b> Convertizor 1 kVA - 400V, 14A, functioneaza cu 1 lance Ø 38/50mm	525
IM0000486	<b>ST 0486</b> Convertizor 2 kVA - 400V, 28A, functioneaza cu 2 lancei Ø 38/50mm sau 1 lance Ø 60mm	677
IM0000488	<b>ST 0488</b> Convertizor 1 kW - 230V, 14A, functioneaza cu 1 lance Ø 38/50mm	509
IM0000490	<b>ST 0490</b> Convertizor 1,5 kW - 230V, 21A, functioneaza cu 2 lancei Ø 38/50mm sau 1 lance Ø 60mm	663



### Lance si cap vibrant pentru convertizor de inalta frecventa seriile NW / ST

IM0000470	Diametru Ø 38mm, 5 m lungime	296
IM0000472	Diametru Ø 50mm, 5 m lungime	361
IM0000478	Diametru Ø 60mm, 5 m lungime	431
IM0000474	Diametru Ø 70mm, 5 m lungime	523



### Cap vibrant pentru convertizor de inalta frecventa seriile NW si ST

IM0000471	Diametru Ø 38mm	164
IM0000473	Diametru Ø 50mm	197
IM0000479	Diametru Ø 60mm	251
IM0000475	Diametru Ø 70mm	373



### Rigla vibranta Mosquito (nu include rigla)

IM1007043	<b>MSE Mono</b> , Vibratii 11.000 vpm, motor electric 230V, 110 W	513
-----------	---	-----



IM1007042	<b>MSH Honda GX25</b> , Vibratii 7.000 vpm, motor benzina 1 cp	863
-----------	--	-----



### Rigle compatibile cu ambele modele:

IM0007047	Lungime 1,5 m	89,1
IM0007046	Lungime 2 m	116
IM0007045	Lungime 2,5 m	143
IM0007044	Lungime 3 m	169



Cod produs	Descriere produs	Pret Euro (fara TVA)
BT60E	<b>BT60E Elicopter pentru pardoseala 600 mm</b> Motor electric 1,5 kW, 230V / 50 Hz, ambreiaj centrifugal Maner pliabil, vibratii 1,1 - 1,5 m/s Nivel zgomot: 97 - 103 Lwa Greutate echipament: 55 kg Dimensiuni: 1.490x910x600 mm	2.187
BT60H	<b>BT60H 160 Elicopter pentru pardoseala 600 mm</b> Motor Honda GX160, 5,5 cp, ambreiaj centrifugal Maner pliabil, vibratii 1,1 - 1,5 m/s Nivel zgomot: 97 - 103 Lwa Greutate echipament: 63 kg Dimensiuni: 1.490x910x600 mm	1.246
BT90HF	<b>BT90HF 160 Elicopter pentru pardoseala 900 mm</b> Motor Honda GX160, 5,5 cp, ambreiaj centrifugal Maner pliabil, vibratii 1,1 - 1,5 m/s Nivel zgomot: 97 - 103 Lwa Greutate echipament: 78 kg Dimensiuni: 1.850x960x960 mm	1.493
BT120H	<b>BT120H 270 Elicopter pentru pardoseala 1.200 mm</b> Motor Honda GX270, 9.0 cp, ambreiaj centrifugal Maner fix, vibratii 1,1 - 1,5 m/s Nivel zgomot: 97 - 103 Lwa Greutate echipament: 118 kg Dimensiuni: 2.130x1.040x1.250 mm	1.914
F60412	Pale standard 600mm (set 4 buc)	24,6
F60412P	Pale din polipropilena / Combinate 600mm (set 4 buc) albe	54,7
F90416	Pale standard 900mm (set 4 buc)	33,9
C90419	Pale combinate 900mm (set 4 buc)	45,9
FS9043	Pale special combo 900mm (set 4 buc)	41,7
F120416	Pale standard 1.200mm, 1,6mm (set 4 buc)	39,2
C120419	Pale combinate 1.200mm (set 4 buc)	57,9
FS12043	Pale special combo 1.200mm (set 4 buc)	50,4
	 <p>Pale standard 600      Pale polipropilena      Pale standard (900 si 1200)      Pale combo      Pale combinate</p>	
FP604	Disc comparator Galvanizat pentru finisare beton, diam. 600mm	53,5
FP9408P	Disc comparator Vopsit pentru finisare beton, diam. 900mm	99,9
FP11708P	Disc comparator Vopsit pentru finisare beton, diam. 1.200mm	163
		
IMBT350072	<b>Lipa pentru nivelarea, finisarea si perierea betonului, 900mmx200mm</b> Set livrare: Maner compus din 3 elemente x 1,8 m, suport prindere, lipa si perie finisare.	458
		





Cod produs	Descriere produs	Pret Euro (fara TVA)
MK1003661	<b>UH070 Centrala hidraulica</b> Debit 20,5 l/min Presiune 117 bari Motor Subaru EX21 Rezervor combustibil 3,2l, autonomie 2 ore la capacitate maxima Greutate: 44kg	2.717
MK0004735	<b>BH 051V Ciocan hidraulic 5,5kg 2.700bpm</b> Optional spit 240mm lungime si dalta 240mm lungime	1.934
MK0003655	<b>BH 112V Ciocan hidraulic 11kg 1.450bpm</b> Optional spit 450mm lungime si dalta 450mm lungime	1.810
MK0003656	<b>BH 116V Ciocan hidraulic 16,5kg 1.650bpm</b> Optional accesorii compatibile Spit - lungime 450mm Dalta - lungime 450mm Dalta latime 75mm, lungime 450mm Dalta latime 125mm, lungime 380mm	2.242
	<b>BH 116VC Ciocan hidraulic 21.5kg 1.650bpm</b> Optional accesorii compatibile Spit - lungime 450mm Dalta - lungime 450mm Dalta latime 75mm, lungime 450mm Dalta latime 125mm, lungime 380mm	2.527
MK0003657	<b>BH 201V Ciocan hidraulic 26kg 1.050bpm</b> Optional accesorii compatibile Spit - lungime 450mm Dalta - lungime 450mm Dalta latime 75mm, lungime 450mm Dalta latime 125mm, lungime 380mm	2.474
MK0004741	<b>CH 130 Fierastrau circular diam. max 300mm, 3.200 rpm, 8kg</b>	2.320
MK1003661	<b>PH 301 Pompa submersibila diam. 3", debit 780 l/min.</b> UH070-EXH Set furtune flexibile 5 m lungime	2.717 395

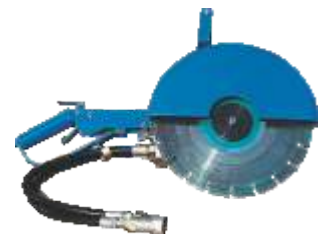

# BISONTE CONSTRUCTII



**Compactare**  
Pagina 19



**Masini de taiat  
asfalt/beton**  
Pagina 22



**Masini de taiat  
caramida/BCA/metale**  
ghilotina pavele  
Pagina 23



**Discuri diamantate  
segmentate**  
Pagina 24



**Masini de taiat  
gresie/faianta**  
Ghilotina  
Pagina 25



**Elicoptere pentru  
slefuit si finisat  
pardoseli**  
Pagina 26



**Sisteme vibrare  
beton**  
Pagina 27



**Pompe pentru  
gleturi | tencuit**  
Pagina 28



**Pompe airless  
zugravit | vopsit**  
Pagina 32



**Slefuire pereti | tavan**  
Aspiratoare  
si malaxoare  
Pagina 37



**Compressoare  
electrice**  
Pagina 39



**Aparate de sudura**  
Taiere cu plasma  
Pagina 41



**Scari profesionale  
si universale**  
Pagina 43



**Betoniere**  
Roabe  
Pagina 45



**Masini de carotat**  
Pagina 46



**Generatoare  
open**  
Pagina 47





# Mai-uri compactoare

Cod produs

Descriere produs

Pret Euro (fara TVA)

BT1003674 **MC75-H GXR** Mai compactor 72kg

1.740

Forța de impact: 13 kN  
Motor benzina Honda GX R120 - 4 timpi - 3,5 cp  
Sistem dublu de filtrare aer  
Rezervor pentru benzina din poliuretan  
Contor de ore și tuometru



6426390839831 **MC72-H** Mai compactor 68kg

1.480

Forța de impact: 10kN  
Motor benzina Honda GX100 - 4 timpi - 2,8 cp  
Cadru de protecție împotriva avarierii motorului  
Rezervor pentru benzina din poliuretan  
Contor de ore și tuometru



BT1009479 **MC72H-GXR** Mai compactor 68kg

1.520

Forța de impact: 10kN  
Motor benzina Honda GX120R - 4 timpi - 3,5 cp  
Cadru de protecție împotriva avarierii motorului  
Rezervor pentru benzina din poliuretan  
Contor de ore și tuometru



6426390839817 **MC80-L** Mai compactor 79kg

980

Forța de impact: 10,7kN  
Motor benzina Loncin 168 - 4 timpi - 5,5 cp  
Cadru de protecție împotriva avarierii motorului  
Rezervor pentru benzina din poliuretan  
Contor de ore și tuometru



Optionale

BT0001847 Roti pentru transport mai compactor

42,1

BT0004370 Ulei motor pe benzina, Italia Star 10W-40 fabricat in Romania, bidon 1L

5,4





# Placi compactoare unidirectionale

Cod produs	Descriere produs	Pret Euro (fara TVA)
6426390839824	<b>PC60-L</b> Placa compactoare 54 kg, Forta compactare 10,5kN Motor Loncin 154F, 2,8 cp, 4 timpi, combustibil benzina Maner pliabil, roti transport incluse, protectie talpa	420
BT1003676	<b>PC65-H</b> Placa compactoare 60kg, Forta compactare 10,5kN Motor Honda GX160 - 4timpi - 5,5cp, combustibil benzina Manere pliabile, roti transport incluse, protectie talpa	890
6426390839855	<b>PC70-H</b> Placa compactoare 64kg, Forta compactare 11kN Motor Honda GX160 - 4timpi - 5,5 cp, combustibil: benzina Talpa masiva din otel turnat, protectie talpa Rezervor apa inclus, manere pliabile, roti transport incluse	960
6426390839848	<b>PC70-L</b> Placa compactoare 65 kg, Forta compactare 11,5 kN Motor Loncin 200F, 6,5 cp, combustibil benzina Talpa masiva din otel turnat, protectie talpa Manere pliabile, roti transport incluse	580
6426390839862	<b>PC90-H</b> Placa compactoare 95kg, Forta compactare 13kN Motor HondaGX160 - 4timpi - 5,5 cp, combustibil: benzina Talpa masiva din otel turnat, protectie talpa Rezervor apa inclus, manere pliabile, roti transport incluse	1.010
6426390839596	<b>PC90-L</b> Idem, motor Loncin G200F, 6,5 cp	690
BT1007064	<b>PC90-B&amp;S</b> Idem, motor Briggs & Stratton, 6,5 cp	880
BT1004194	<b>PC100-H</b> Placa compactoare 102 kg; Forta compactare 20kN Motor Honda GX160 - 4 timpi 5,5 cp, combustibil benzina	990
<b>Accesorii consumabile</b>		
BT0001945	Protectie talpa PC65/70 pentru vibrocompactare pavele/dale	25,8
BT0001946	Set roti pentru transport placa compactoare Pc65	37,2
BT0004107	Rezervor apa PC90 (complet echipat)	97,7
BT0002784	Protectie talpa PC65 / PC70 incolor	43,4
BT0001951	Protectie talpa PC90 pentru vibrocompactare pavele/dale	28,1
BT0002785	Protectie talpa PC90 incolor	37,5
BT0001970	Set roti pentru transport placa compactoare PC90	37,2
BT0003595	Rezervor apa Pc70 (complet echipat)	97,7
BT0003772	Rezervor apa PC90 (doar rezervor)	82,6
BT0004370	Ulei motor pe benzina, Italia Star 10W-40 fabricat in Romania, bidon 1L	5,4





## Placi compactoare reversibile

Cod produs	Descriere produs	Pret Euro (fara TVA)
BT1004922	<b>PCR160-H</b> Placa compactoare 160kg; Forta compactare 30,5kN Motor Honda, GX160, 5,5 cp Combustibil: benzina, maner pliabil Maneta mecanica schimbare sens-directie Talpa laminata, fara extensii (nu se pot atasa) Contor de ore si tuometru	1.400
BT1003679	<b>PCR160-HE</b> Idem, motor Honda GX160, 5,5 cp, talpa fonta cu extensii	1.650
BT1005981	<b>PCR160-LE</b> Idem, motor benzina Loncin G270F, 9 cp talpa fonta cu extensii	1.450
BT1003839	<b>PCR255-H</b> Placa compactoare 255kg; Forta compactare 38 kN Motor Honda GX270, 4 timpi - 8,5 cp Combustibil: benzina, maner pliabil Maneta mecanica schimbare sens-directie Extensii laterale incluse, contor de ore si tuometru	2.806
BT1006273	<b>PCR255-H390</b> Idem, motor benzina Honda GX390, 13 cp	2.897
BT1004195	<b>PCR255-L</b> Idem, motor benzina Loncin G390F, 13 cp	1.955
BT1008988	<b>PCR255-LK</b> , Idem, motor diesel Lombardini / Kohler 15LD 350, 7,5 cp	3.066
BT1005621	<b>PCR320-H</b> Placa compactoare 305kg; Forta compactare 38kN Motor Honda GX390 - 4timpi - 11,7 cp, combustibil benzina Maner pliabil, maneta mecanica schimbare sens-directie Extensii laterale incluse, contor de ore si tuometru	3.513
BT1003231	<b>PCR320-LK</b> Idem, motor Diesel Lombardini / Kohler 15LD350, 7,5 cp	3.795
BT1004197	<b>PCR400-H</b> Placa compactoare 400kg, Forta compactare 40kN Motor Honda GX390 - 11,7 cp, combustibil benzina Sistem hidraulic pentru schimbare sens-directie Contor de ore si tuometru, manere pliabile	5.623
BT1004198	<b>PCR400-LK</b> , Idem, motor diesel Lombardini / Kohler 15LD440 - 10,9 cp	5.893
BT1003180	<b>PCR520-LK</b> Placa compactoare 520kg; Forta compactare 60kN Motor diesel Lombardini 15LD440 - 10,9 cp Pornire automata, baterie inclusa Sistem hidraulic pentru schimbare sens-directie Contor de ore si tuometru, manere pliabile	8.041
BT1005823	<b>CV300-H</b> Cilindru vibrocompactator 266 kg; Forta compactare 13,5 kN Motor Honda GX160, 5,5 cp, benzina Transmisie hidrostatica, latime rola 600 mm	4.980
BT0004370	Ulei motor pe benzina, Italia Star 10W-40 fabricat in Romania, bidon 1L	5,4





# Masini de taiat asfalt / beton

Cod produs	Descriere produs	Pret Euro (fara TVA)
BT1006443+	<b>MD350</b> Masina de debitat portabila cu suport taiere pentru sape, disc 350 mm	941
BT1006444	Adancime max. taiere 115 mm, motor benzina monocilindric in 2 timpi, putere motor 4 cp, turatie motor 8.500 rpm, rezervor combustibil 1,5 l Greutate: 12,5 kg	
BT1003680	<b>MTA400-H</b> Masina de taiat asfalt/beton diam. max. disc 400 mm Motor benzina Honda GX200 - 4 timpi - 5,8 cp Adancime maxima de taiere 150mm Rezervor apa 25L din PPHD Manere reglabile Maneta cu blocare pentru reglare adancime de taiere Greutate utilaj: 90kg Contor de ore si turometru	1.638
BT1007746	<b>MTA400-H</b> Idem, Motor benzina Honda GX270 - 4 timpi - 8,4 cp	1.490
BT1005982	<b>MTA400-L</b> Idem cu motor Loncin G270F, 9 cp	940
BT1006439	<b>MTA401-H</b> Masina de taiat asfalt /beton diam. max. disc 400 mm Motor benzina Honda GX270, 4 timpi, 8,4 cp Adancime max. de taiere 150 mm Roti spate ajustabile central, stanga sau dreapta Greutate: 90 kg Dimensiuni: Lxlxh 670x560x1.400 mm	1.650
BT1005275	<b>MTA501-H</b> Masina de taiat asfalt/ beton diam. max. 500 mm Motor Honda GX390 - 4 timpi - 11,7 cp, combustibil: benzina Adancime max. de taiere 185 mm, contor ore si turometru Rezervor apa 35 l, conector rapid la bidon (se poate detasa pentru a-l reumple), coborare/ridicare usoara a discului datorita cilindrului cu gaz, reglare grila de indicare in functie de dimensiunea discului utilizat, curea transmisie disc mai lata, pin blocare adancime taiere	1.680
BT1007065	<b>MTA501-BS</b> Idem, motor Briggs and Stratton, 13,5 cp	1.350
BT1009540	<b>MTA505H</b> Masina de taiat asfalt/ beton diam. max. 500 mm Motor Honda GX390 - 4 timpi - 13 cp, combustibil: benzina. Adancime max. de taiere 170 mm, contor ore si turometru. Rezervor apa 40 l. Control reglabil pe inaltime a discului. <b>Sistem mecanic pentru avans</b> (permite optimizarea taierii si o durata de viata mai mare a discului)	1.840
BT1009541	<b>MTA505H</b> Idem, motor Loncin G390F 13 cp, diam. max. disc 500 mm	1.240
BT1005239	<b>MSB25-H</b> Masina de scarificat asfalt / beton Motor Honda GX390, 11,7 cp, turatie 3.400-3.600 rpm Latime de lucru 250 mm, Adancime 3 mm / trecere Capacitate rezervor 6,1 l, greutate 115 kg, Dimensiuni Lxlxh 850x490x950 mm	3.604
BT0001966	Disc - steluta pentru masina de scarificat - frezat (pret / bucata)	7
BT0004370	Ulei motor pe benzina, Italia Star 10W-40 fabricat in Romania, bidon 1L	5,4



MTA401-H

**Nou!**

**Nou!**



# Masini de taiat caramida / metale

Cod produs	Descriere produs	Pret Euro (fara TVA)
BT1006434	<b>KTV 400Ei</b> Masina de taiat caramida, marmura, granit, pavele disc 400 mm Lungime taiere 450 mm, adancime taiere la a 2-a trecere 280 mm Motor 230V, 2,2 kW, turatie 2.850 rpm <b>Inverter pentru protectia motorului la tensiune joasa</b> Greutat: 97 kg Dimensiuni: Lxlxh min./max. 1.160x715x1.430 / 1.520 mm	1.380
BT1006436	Disc Ø 400 mm pentru caramida	103
BT1006433	<b>KTV 650E</b> Masina de taiat caramida, marmura, granit, pavele disc 650 mm, Lungime taiere 500 mm, adancime taiere la a 2-a trecere 510 mm Motor 400V, 5,5 kW, turatie 1.400 rpm Greutate: 230 kg Dimensiuni: Lxlxh min./ max. 1.700x1.500x820 mm	2.320
BT1006437	Disc Ø 650 mm pentru caramida	338
BT1006435	<b>GYD 400E</b> Masina de taiat metale, disc 400 mm (nu este inclus) Adancime taiere la 90 de grade 100 x 60 mm Adancime taiere la 45 de grade 100 x 40 mm Motor 400V, 3 kW, turatie 2.850 rpm Greutate: 90 kg. Dimensiuni: Lxlxh 710x620x560 mm	1.402
BT1006443	<b>MD350</b> Masina de debitat portabila (fara carut), geanta transport inclusa Disc 350mm, adancime de taiere 115 mm, motor monocilindric, 2 timpi, 4 cp, turatie motor 8.500 rpm, rezervor benzina 1,5 l Greutate echipament: 12,5 kg. Dimensiuni: Lxlxh 950x450x460 mm	789
BT2000544	Disc universal diamantat 350 mm (pentru MD350)	50,5
BT1009423	<b>TSC470 Masina de taiat BCA</b> , 230V – 1,85 kW, inaltime maxima de taiere 47 cm, masa reglabila 0-90°. Greutate: 185 kg	3.180
BT0009426	Lama continua pentru BCA/caramida (TSC470)	354
BT1009424	<b>TSC505 Masina de taiat BCA/Caramida</b> , 230V – 1,40 kW, inaltime maxima de taiere 50 cm, avans controlat. Greutate: 220 kg	5.480
BT0009427	Lama continua pentru BCA (TSC505)	394
BT1009425	<b>TSC650 Masina de taiat BCA/Caramida</b> , 230V – 1,85 kW, inaltime maxima de taiere 65 cm, masa reglabila 0-90°. Greutate: 207 kg	4.120
BT0009428	Lama continua pentru BCA (TSC650)	374



TSC470



TSC505



TSC650





# Discuri Bisonte diamantate segmentate

Cod produs

Descriere produs

Pret Euro (fara TVA)

## **(Nou!)** DISC DIAMANTAT SEGMENTAT - SERIA GENERAL

Pentru caramida, beton, marmura, granit - include segmente ingrosate cu durabilitate mare si rezistenta la deformare

BT0009547	Disc Ø=105mm, Ø interior 25,4, dim. segmente (h x grosime x L) 10x2,3x30 mm	8,3
BT0009548	Disc Ø=115mm, Ø interior 25,4, dim. segmente (h x grosime x L) 10x2,3x30 mm	9,4
BT0009549	Disc Ø=125mm, Ø interior 25,4, dim. segmente (h x grosime x L) 10x2,3x30 mm	10,5
BT0009550	Disc Ø=180mm, Ø interior 25,4, dim. segmente (h x grosime x L) 10x2,6x32 mm	16,5
BT0009521	Disc Ø=400mm, Ø interior 25,4, dim. segmente (h x grosime x L) 10x3,5x38 mm	53,9
BT0009522	Disc Ø=600mm, Ø interior 25,4, dim. segmente (h x grosime x L) 12x4,5x38 mm	164
BT0009523	Disc Ø=650mm, Ø interior 25,4, dim. segmente (h x grosime x L) 12x4,5x38 mm	188
BT0009524	Disc Ø=750mm, Ø interior 25,4, dim. segmente (h x grosime x L) 12x4,5x38 mm	266



## **(Nou!)** DISC DIAMANTAT SEGMENTAT - SERIA SILENT

Pentru caramida, beton, marmura, granit - include segmente drepte si trapezoidale cu ascutire ridicata, in plus pe suprafata discului se gasesc fante trasate laser, care confera silentiozitate si durata lunga de viata.

BT0009525	Disc Ø=250mm, Ø interior 25,4, dim. segmente (h x grosime x L) 10x2,6x38 mm	34,3
BT0009526	Disc Ø=300mm, Ø interior 25,4, dim. segmente (h x grosime x L) 10x3,0x38 mm	53,6
BT0009527	Disc Ø=350mm, Ø interior 25,4, dim. segmente (h x grosime x L) 10x3,2x38 mm	61,8
BT0009528	Disc Ø=400mm, Ø interior 25,4, dim. segmente (h x grosime x L) 10x3,5x38 mm	83
BT0009529	Disc Ø=500mm, Ø interior 25,4, dim. segmente (h x grosime x L) 10x4,0x38 mm	166
BT0009530	Disc Ø=600mm, Ø interior 25,4, dim. segmente (h x grosime x L) 10x4,5x38 mm	290



## **(Nou!)** DISC DIAMANTAT SEGMENTAT - SERIA ASFALT

Pentru asfalt, beton proaspat (sapa), beton - dedicat taierii de asfalt si beton proaspat cu masini profesionale de putere max.40 CP

BT0009531	Disc Ø=350mm, Ø interior 25,4, dim.segmente(h x grosime x L) 12x3,2x38 mm	78,1
BT0009532	Disc Ø=400mm, Ø interior 25,4, dim.segmente(h x grosime x L) 12x3,5x38 mm	101
BT0009533	Disc Ø=450mm, Ø interior 25,4, dim.segmente(h x grosime x L) 12x3,5x38 mm	126
BT0009534	Disc Ø=500mm, Ø interior 25,4, dim.segmente(h x grosime x L) 12x4,0x38 mm	159



## **(Nou!)** DISC DIAMANTAT SEGMENTAT - SERIA TURBO-A

Disc diamantat segmentat alternativ, beton rutier, asfalt si beton proaspat (toate tipurile de sapa), include trei tipuri de segmente, dispuse alternativ pe disc, tehnologie prin sudare laser DrFritsch Germania

BT0009535	Disc Ø=350mm, Ø interior 25,4, dim.segmente(h x grosime x L) 20x3,2x24 mm	50,7
BT0009536	Disc Ø=400mm, Ø interior 25,4, dim.segmente(h x grosime x L) 20x3,2x28 mm	60,0
BT0009537	Disc Ø=500mm, Ø interior 25,4, dim.segmente(h x grosime x L) 20x3,5x36 mm	99,3

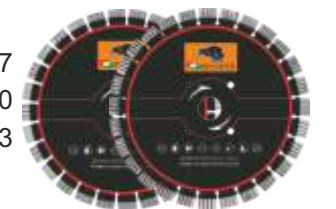

BT2000544	Disc universal diamantat 350 mm, prindere 25.4 mm compatibil cu MD350	50,5
BT0001848	Disc diamantat 400mm - STANDARD - pentru taiere asfalt/beton	93,6
BT0001849	Disc diamantat 400mm - LONG LIFE - pentru taiere asfalt/beton	119
BT0001850	Disc diamantat 500mm - STANDARD - pentru taiere asfalt/beton	159
BT0001851	Disc diamantat 500mm - LONG LIFE - pentru taiere asfalt/beton	185

**LICHIDARE  
STOC**





# Masini de taiat gresie / faianta Ghilotina pavele

Cod produs

Descriere produs

Pret Euro (fara TVA)

## Masini de taiat gresie / faianta LEGGERA

Caracteristici:

Multifuncțional, putere și precizie sunt principalele caracteristici ale acestui echipament pentru taiat gresie și faianta;

LEGGERA poate tăia rapid și precis toate tipurile de gresie și faianta, cu grosimea de la 5 la 15 mm.

Chiar și tăierea diagonală este sigură și simplă;

Echipament proiectat pentru tăierea tuturor tipurilor de ceramică disponibile, porțelan și plăci de sticlă, inclusiv mozaic de sticlă;

Mâner ergonomic precis și extrem de puternic;

Transportul și depozitarea sunt rapide și ușoare;

Masina este dotată cu picioruse cauciucate antiderapante;

Incizia se efectuează prin împingere – metoda eficientă în cazul tuturor tipurilor de materiale;



8021410068420 **Leggera 70**, L.max. 670 mm, grosime de taiere 5-15 mm, dimensiune max. a 160

**(Nou!)** placii pentru taieri pe diagonala 470x470 mm, rotita taiere Ø 15 x 6 x 1,5 mm



8021410068437 **Leggera 92**, L.max. 920 mm, grosime de taiere 5-15 mm, dimensiune max. a 205

**(Nou!)** placii pentru taieri pe diagonala 650x650 mm, rotita taiere Ø 15 x 6 x 1,5 mm



8021410068444 **Leggera 137**, L.max. 1.370 mm, grosime de taiere 5-15 mm, dimensiune max. 265

**(Nou!)** a placii pentru taieri pe diagonala 965x965 mm, rotita taiere Ø 15 x 6 x 1,5 mm



## Masina de taiat gresie / faianta BASIC 60

Caracteristici:

Multifuncțional, putere și precizie sunt principalele caracteristici ale acestui echipament pentru taiat gresie și faianta;

BASIC poate tăia rapid și precis toate tipurile de gresie și faianta, cu grosimea de la 4 la 12 mm.

Chiar și tăierea diagonală este sigură și simplă;

Echipament proiectat pentru tăierea tuturor tipurilor de ceramică disponibile, porțelan și plăci de sticlă, inclusiv mozaic de sticlă;

Mâner ergonomic precis și extrem de puternic;

Transportul și depozitarea sunt rapide și ușoare;

Masina este dotată cu picioruse cauciucate antiderapante;

Incizia se efectuează prin împingere - metoda eficientă în cazul tuturor tipurilor de materiale;

5.000.000 de cicluri garantate fără uzură.

• Fără lubrifiere (Cuplul din crom și IXEF este auto-lubrifiat).

• Fără mentenanță (Bare cromate foarte rezistente).

3161304182391 **Basic 60**, L.max. 600 mm, grosime de taiere 4-12 mm, dimensiune max. a 82,0

**(Nou!)** placii pentru taieri pe diagonala 420x420 mm, rotita taiere Ø 15 x 6 x 1,5 mm



8021410020091 Rotita taiere pentru masinile Leggera și Basic 60

6,0



BT1001919 **GP42 Ghilotina** manuala pentru taiat pavele și prefabricate usoare din beton 208

Latime max.420mm

Inaltime max. 140mm

BT0002559 Set 2 buc. lame ghilotina GP42

13,1





# Elicoptere pentru slefuit / finisat pardoseli

Cod produs	Descriere produs	Pret Euro (fara TVA)
BT1004524	<b>EP600-E</b> Masina de slefuit sapa/beton - <b>Elicopter cu diam. 600mm</b> Motor electric 230V, 2,2 kW Maner pliabil, 4 palete standard incluse Greutate utilaj: 45 kg	890
BT1004525	<b>EP600-H</b> Masina de slefuit sapa/beton - <b>Elicopter cu diam. 600mm</b> Motor <b>Honda GX160</b> - 4 timpi - 5,5 cp, combustibil: benzina Maner pliabil, 4 palete standard incluse Greutate utilaj: 60kg	950
BT1003682	<b>EP900-H</b> Masina de slefuit sapa/beton - <b>Elicopter cu diam. 900mm</b> Motor <b>Honda GX160</b> - 4 timpi - 5,5 cp, combustibil: benzina Maner pliabil, 4 palete standard incluse Greutate utilaj: 80kg	980
BT1003841	<b>EP1200-H</b> Masina de slefuit sapa/beton - <b>Elicopter cu diam. 1.200mm</b> Motor <b>Honda GX270</b> - 4 timpi - 8,5 cp, combustibil: benzina Maner pliabil, 4 palete standard incluse Greutate utilaj: 99kg	1.340
BT0002438	Pale standard 600mm (set 4 buc.)	30,4
BT0006634	Pale combinate 600mm (set 4 buc.)	37,5
BT0006631	Pale special Combo 600mm (set 4 buc.)	51,5
BT0002451	Pale standard 900mm (set 4 buc.)	37,5
BT0006635	Pale combinate 900mm (set 4 buc.)	63,2
BT0006632	Pale special combo 900mm (set 4 buc.)	58,4
BT0002257	Pale standard 1.200mm (set 4 buc.)	49,2
BT0006636	Pale combinate 1.200mm (set 4 buc.)	53,8
BT0006633	Pale special Combo 1.200mm (set 4 buc.)	72,6
BT0001931	Disc comparator pentru finisare beton, diam. 600mm	53,8
BT0001934	Disc comparator pentru finisare beton, diam. 900mm	77,2
BT0002256	Disc comparator pentru finisare beton, diam. 1.200mm	98,3
<b>Lipa manuala pentru finisat beton, lungime maner 5 m (2 x 2,5m)</b>		
BT1005984	Maner lipa compatibil cu profilurile de mai jos Tip 1 - Profil rectangular din aluminiu	159
BT1005985	Lungime rigla 2,44 m	67,9
BT1005986	Lungime rigla 3 m Tip 2 - Aluminiu extrudat capete rotunjite	91,3
BT1005987	Lungime rigla 1,22 m	131
BT1005988	Lungime rigla 1,83 m Tip 3 - Tabla, capete rotunjite	211
BT1005989	Lungime rigla 1,22 m	63,2
BT1005990	Lungime 1,53 m	79,6
BT1005991	Lungime 1,83 m	93,6
BT1005992	Carucior pentru imprastiere materiale finisaj pardoseli Capacitate transport 150kg / 0,18m <sup>3</sup>	1.090

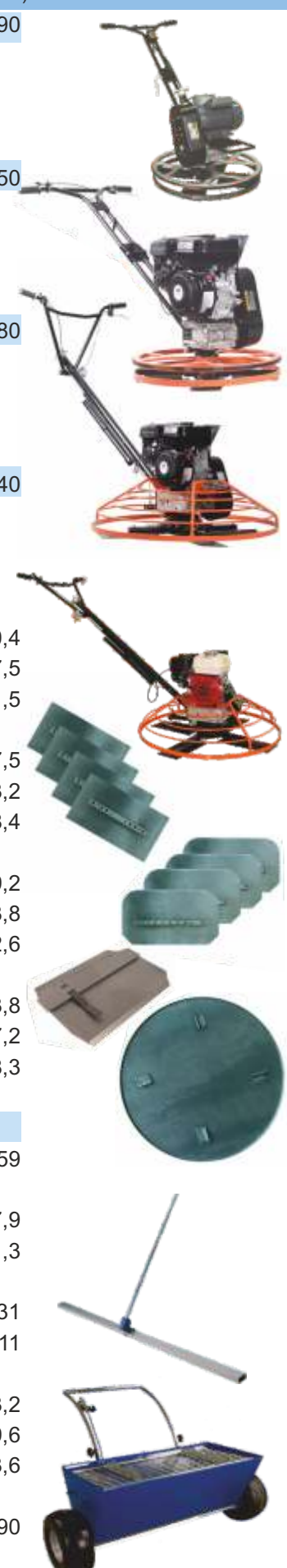



# Sisteme de vibrare a betonului

Cod produs	Descriere produs	Pret Euro (fara TVA)
BT1001822	<b>VIB-E</b> Vibrator pentru uz in imersie beton Motor electric cu putere de 550W, alimentare 230V-50Hz Viteza de lucru: 2.800rpm Greutate utilaj: 7,2kg	155
BT0001823	Lance vibrare 4m lungime, cap vibrare diam. 28mm	103
BT0001824	Lance vibrare 4m lungime, cap vibrare diam. 32mm	112
BT0001825	Lance vibrare 4m lungime, cap vibrare diam. 38mm	115
BT0001826	Lance vibrare 4m lungime, cap vibrare diam. 45mm	122
BT1002258	<b>VIB-DE Plus</b> Vibrator pentru uz in imersie beton Motor electric cu putere de 2.300W, alimentare 230V-50Hz Viteza de lucru: 18.000 rpm Greutate utilaj: 8kg	295
BT1005234	Lance + cap vibrare 4 m lungime, Ø38 mm	236
BT1005235	Lance + cap vibrare 5 m lungime, Ø38 mm	250
BT1005617	Lance + cap vibrare 4 m lungime, Ø48 mm	262
BT1005618	Lance + cap vibrare 5 m lungime, Ø48 mm	276
BT1005619	Lance + cap vibrare 5 m lungime, Ø58 mm	311
BT1005236	<b>VIB-H</b> Vibrator pentru uz in imersie beton Motor Honda GX35 4 timpi, 1,3 cp, combustibil benzina Viteza de lucru: 7.500 rpm Greutate utilaj: 7,5 kg Vibratorului VIB-H i se adauga o lance de mai jos:	520
BT1005237	Lance vibrare 3m lungime, cap vibrare diam. 32 mm	81,9
BT1005238	Lance vibrare 3m lungime, cap vibrare diam. 38 mm	88,9
<b>Rigle vibrante motorizare Honda cu 1 sau 2 manere</b>		
BT1004944	<b>RVB1-H</b> Rigla vibranta, Motor Honda GX35 - 4timpi - 1,6 cp (1 maner)	845
BT1003818	<b>RVB2-H</b> Rigla vibranta, Motor Honda GX35 - 4timpi - 1,6 cp (2 manere) Greutate utilaj: 15 / 20kg	880
BT0002590	Rigla aluminiu pentru vibrare beton, lungime 1,9m	84
BT0001852	Rigla aluminiu pentru vibrare beton, lungime 2,5m	112
BT0001853	Rigla aluminiu pentru vibrare beton, lungime 3m	136
BT0003360	Rigla aluminiu pentru vibrare beton, lungime 3,7m	171
BT0001854	Rigla aluminiu pentru vibrare beton, lungime 4,5m	171
BT0004370	Ulei motor pe benzina, Italia Star 10W-40 fabricat in Romania, bidon 1L	5,4





# Pompe cu Snec pentru Gleturi si Decorative

Cod produs

Descriere produs

Pret Euro (fara TVA)

BT1008427 **PCS-T5 Pompa cu Snec pentru Gleturi si Decorative** 1.980

Utilaj echipat complet, gata de lucru  
Debit material: 15 l/min.;  
Granulometrie max. 3 mm; Presiune max. 20 bar  
Capacitate recipient material: 40 l  
Motor electric: 230V - 50 Hz, 3,4 kW; Greutate: 42 kg  
**Echipare standard:** 1 rotor; 1 stator; 1 lance aplicare material; 3 duze metalice; 6 bureti curatare furtun; 1 furtun material diam. 19 mm, cuplaje rapide, 117 bar; 1 furtun aer, cuplaje rapide, 13 mm; 1 perie curatare



Bt2008428 Rotor pentru PCS-T5 76,3  
BT2008429 Stator pentru PCS-T5 46,9  
BT7009002600 Rotor Mixer 8 pentru PCS-T5 80,5  
BT3F00528400 Stator Mixer 8 pentru PCS-T5 67,0  
BT0008877 Duza metalica 4 mm 4,8  
BT0008878 Duza ceramica 6 mm 4,8  
BT0008879 Duza ceramica 8 mm 4,8  
BT0008942 Lance aplicare material 116



BT1008866 **PCS - HP15 Pompa cu Snec pentru Gleturi si Decorative** 6.090

Utilaj echipat complet, gata de lucru  
Debit material: 6 l/min.;  
Granulometrie max. 1 - 2 mm; Presiune max. 120 bar  
Capacitate recipient material: 57 l  
Motor electric: 230V - 50 Hz; 2,2 kW; Greutate: 62 kg  
**Echipare standard:** 1 rotor; 1 stator; 1 pistol airless; 1 duza 443; 1 garda protectie duza; 1 furtun material 15m, diam. 16 mm; 1 cablu comanda electrica 10 m; 1 kit filtrare pe furtun mesh 18; 1 manometru



## Accesorii si consumabile PCS-HP15

BT7009107700 Rotor Mixer Jet 2 135  
BT3F00529100 Stator Mixer Jet 2 109

BT1008870 **Kit tencuieli decorative** (necesar compresor de min. 330 l/min) 517

Kit-ul conține: 1 x Furtun aer 10m, sistem conexiune Geka;  
1 x Adaptor pentru pistol cu sistem de dozare a aerului (se montează pe pistol pentru facilitarea amestecului material-aer);  
3 x Duze pulverizare pentru decorativă, Ø 4, 5 si 6 mm;  
2 x Bureți spongioși pentru curățare furtun material.



BT1008869 **Kit zugraveli** 909

Kit-ul conține: 1 x Furtun de material Ø 13 mm, lungime 15 m, dotat cu o supapă unisens pentru un debit constant de material;  
1 x Cablul comanda electrica;  
1 x Pistol airless cu comandă electrică;  
1 x Element de susținere a duzei (guard tip);  
Nota: Duza airless nu este inclusă.



BTEU30829 Filru mesh 10 grosier 26,8  
BTEU30667 Filtru mesh 18 mediu 26,8  
BTEU30668 Filtru mesh 30 fin 26,8





# Masini de tencuit

Cod produs	Descriere produs	Pret Euro (fara TVA)
------------	------------------	----------------------

**BT1008757 PCS-K4 Masina de tencuit trifazic** - Utilaj echipat complet, gata de lucru **4.870**

Debit material: 40 l/min. Granulometrie max. 0-3 mm; Presiune max. 5.5 bar  
 Capacitate recipient material: 130 l. Motor electric: 400V - 50 Hz, 6.4 kW  
 Compresor aer: 250 l/min. - 5,5 bar. Greutate masina: 285 kg  
 Suport integrat pentru montarea rotorului in statorul cu pin  
**Echipare standard:** Compresor; Pompa apa; Gratar detasabil cu rupere a sacului; 4 roti din care 2 directionale si 1 cu frana; Stator si rotor D 6-3; Cablu cu stecher 25m; Furtun material 15 m, diam. 25mm; Furtun apa 10m, diam. 19 mm; Furtun aer 16 m, diam. 9.52 mm; Mixer standard; Lance L 70 cm



**BT1008758 PCS-K35 Masina de tencuit monofazica** - Utilaj echipat complet, gata de lucru **5.980**

Debit material: 20 l/min. Granulometrie max. 0-3 mm;  
 Presiune max. 5.5 bar Capacitate recipient material: 130 l  
 Putere motor instalata: 230V - 50 Hz, 4.9 kW  
 Compresor aer DELTA Germania: 180 l/min. - 3,8bar. Greutate masina: 285kg  
**Echipare standard:** Compresor; Pompa apa; Gratar detasabil cu rupere a sacului; 4 roti din care 2 directionale si 1 cu frana; Stator si rotor D 6-3; 1 cablu cu stecher 25m; Furtun material 15 m, diam. 25mm; Furtun apa 10m, diam. 19 mm; Furtun aer 16 m, diam. 9.52mm; Mixer standard; Lance L 70 cm

**NOU!**  
 Compresor  
 DELTA  
 Germania



## Accesorii / consumabile pentru pompele de tencuiala

BT0008873 Rotor Mixer 1 Italia D6-3 **54,0**

BT0008871 Stator Mixer 1 Italia D6-3 Drept **38,0**

BT0008872 Stator Mixer 1 Italia D6-3 Turbo Twister **40,0**

Debit max.: 22 l/min  
 Presiune max.: 30 bar  
 Granulometrie max.: 3 mm

BT0008876 Rotor Mixer 2 Italia D7-2.5 **54,0**

BT0008874 Stator Mixer 2 Italia D7-2.5 Drept cu pin blocaj **40,0**

BT0008875 Stator Mixer 2 Italia D7-2.5 Turbo Twister cu pin blocaj **43,0**

Debit max.: 27 l/min  
 Presiune max.: 30 bar  
 Granulometrie max.: 3mm

BT7009029000 Rotor Mixer 3 Italia D8-2 **52,0**

BT3F00612100 Stator Mixer 3 Italia D8-2 **38,0**

Debit max.: 32 l/min  
 Presiune max.: 25 bar  
 Granulometrie max.: 3mm

BT7009012500 Rotor Mixer 30 pentru PCS-K35 **54,0**

BT3F00618000 Stator Mixer 30 pentru PCS-K35 **42,0**

Debit max.: 25 l/min  
 Presiune max.: 20 bar  
 Granulometrie max.: 3mm

BT7009009000 Rotor Mixer 32 pentru PCS-K35 **54,0**

BT3F00618500 Stator Mixer 32 pentru PCS-K35 **40,0**

Debit max.: 30 l/min  
 Presiune max.: 25 bar  
 Granulometrie max.: 3mm

BT7009049500 Rotor Mixer 4 Italia **52,0**

BT3F00613000 Stator Mixer 4 Italia **38,0**

Debit max.: 40 l/min  
 Presiune max.: 25 bar  
 Granulometrie max.: 3mm

BT0009103 Capac Siloz PCS-K4 **440**

BT0009104 Senzor pentru Siloz PCS-K4 **418**



BT1008881 Lance din aluminiu pentru aplicare material L45 cm; D35 mm **64,1**

BT1008882 Lance din PPR pentru aplicare material L70 cm; D25 mm **65,0**

BT1009102 Lance din PPR pentru aplicare material L120 cm; D25 mm **65,0**

BT2008883 Duza 12 mm **1,8**

BT2008884 Duza 14 mm **1,8**

BT0008886 Mixer Standard pentru PCS-K4 si PCS-K35 **29**





# Masini pentru aplicat gleturi de nivelare si finisare / decorativa

Cod produs

Descriere produs

Pret Euro (fara TVA)

BT1009071 **PCS-MS100 Pompa pentru aplicat gleturi de nivelare si finisare / decorativa**

8.990

Debit material 6 l/min.  
Granulometrie max. 1 mm, presiune max. 110 bar  
Capacitate cuva material 60 l  
Motor electric 230V / 50 Hz; Putere motor 2.2 kW  
Duza max. 0.045"  
Greutate echipament 88 kg; Dimensiuni 1.230x720x660 mm

### Specificatii Mixer PCS-MS100

Volum cuva material 40 l  
Voltaj 230V / 50 Hz; Putere motor 0.75 kW  
Turatie malaxor inainte / inapoi 280 rpm  
Distribuitor de apa reglabil incorporat  
Greutate 41 kg; Dimensiuni 810x720x660 mm

### Echipe standard:

Pompa PCS-MS100; mixer; stator si rotor Mixer Jet 2; 1 furtun material diam. 16 mm, 20m lungime; manometru; pistol cu garda de protectie pentru duza; duza 443

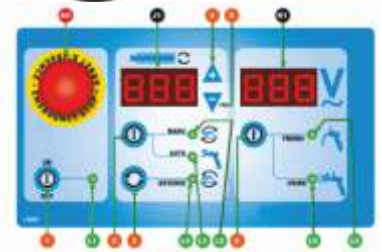

BT3F00529100 **Stator Mixer Jet 2** debit material 10 l/min.; turatii 400 rpm; presiune 140 bar  
Granulometrie max. 2 mm; diametru stator 51 mm, 310 mm lungime

109

BT7009107700 **Rotor Mixer Jet 2** turatii 400 rpm

135



BT1008870 **Kit tencuieli decorative**

517

1 furtun aer 10m lungime, conexiune Geka  
1 Adaptor pentru pistol cu sistem de dozare a aerului (se monteaza pe pistol pentru facilitarea amestecului material - aer)  
3 duze pulverizare pentru decorativa diametru 4, 5 si 6 mm  
2 bureti spongiosi pentru curatare furtun material



BT1008869 **Kit zugraveli**

909

1 furtun material diametru 13 mm, 15 m lungime dotat cu supata unisens pentru un debit constant de material  
1 cablu comanda electrica  
1 pistol airless cu comanda electrica  
1 cap protectie duza



BTEU30829 Filtru mesh 10 fin

26,8

BTEU30667 Filtru mesh 18 mediu

26,8

BTEU30668 Filtru mesh 30 grosier

26,8





# Masini pentru aplicat gleturi de nivelare si finisare / decorativa

Cod produs

Descriere produs

Pret Euro (fara TVA)

BT9110007300 **PCS-MX10 Pompa multifunctionala cu snec pentru tencuieli si gleturi** 3.790

### preamestecate

Debit material 8-26 l/min.

Granulometrie max. 3 mm, presiune pulverizare 0-20 bar

Capacitate cuva material 30 l

Motor electric 230V / 50 Hz; Putere motor 2.2 kW

Greutate echipament 55 kg; Dimensiuni 900x450x620 mm

### Caracteristici PCS-MX10:

Mașină compactă și versatilă.

Ideala pentru mortare, adezivi, rosturi și finisaje.

Utilizati impreuna cu mixerul continuu orizontal Bisonte MIX PRO 70 pentru eficienta si calitate maxima.

### Echipare standard:

1 x Spray degripant

1 x 15 m furtun material Ø 25

1 x 16 m furtun aer Ø 13 GEKA

1 x Lance pentru materiale preamestecate

1 x Kit de întreținere



### OPTIONAL

BT8100005700 **Kit aplicare adezivi, hidroizolatii, glet, tinci** 819

Include: Lance aplicare adezivi, cablu lance 17 m, kit de pulverizare lance de finisare



4004025075537 **Compresor electric Wagner C330/03** 808

Debit aer 330 l/min, presiune de lucru 10 bar, capacitate rezervor aer 3 l



BTEU30915 **MIX PRO 70 Malaxor orizontal continuu pentru glet** 3.980

Debit material 250 l/h.

Granulometrie max. 3 mm, presiune pulverizare 0-20 bar

Capacitate cuva material 30 l

Motor electric 230V / 50 Hz, 10A; Putere motor 0,75 kW

Greutate (cu cadru): 60kg; Dimensiuni de lucru (cu cadru) 980x730x1.290 mm

### Caracteristici MIX PRO 70:

Malaxorul MIXPRO 70 permite o amestecare rapidă și omogenă a produselor sub formă de pulbere.

Este echipat cu un regulator de viteză și apometru.

Cadru reglabil în 4 poziții.

Se pot folosi toate tipurile de produse pulbere monocomponente.

Panou de control cu afișaj digital ușor de utilizat.





# Pompe airless pentru zugravit / vopsit

Cod produs

Descriere produs

Pret Euro (fara TVA)

BT1009042 **PAZ-20X Pompa airless cu piston pentru zugraveli/vopsitorii (cuva incl.)** 590

Motor electric 1.100W, alimentare 230V - 50 Hz  
Debit de lucru 2 l/min. Duza max. 0,021"  
Presiune de lucru 200 bar, vascozitate medie - mare  
Pachet livrare standard: cuva material 6L, pistol airless, duza 517, 15m furtun airless 1/4", extensie pistol 45 cm, ulei de lubrifiere



BT1009453 **PAZ-20X Pompa airless cu piston pentru zugraveli/vopsitorii (fara cuva)** 550

BT1009449 **Cuva material 6L pentru PAZ-20X** 29,0

BT1009043 **PAZ-24X Pompa airless cu piston pentru zugraveli/vopsitorii** 740

Motor electric 1.300W, alimentare 230V - 50 Hz  
Debit de lucru 2,4 l/min. Duza max. 0,023"  
Presiune de lucru 227 bar, vascozitate medie - mare  
Pachet livrare standard: pompa, pistol airless, duza 517, 15m furtun airless 1/4", extensie pistol 45 cm, ulei de lubrifiere



BT1009044 **PAZ-28X Pompa airless cu piston pentru zugraveli/vopsitorii** 940

Motor electric 2.200W, alimentare 230V - 50 Hz  
Debit de lucru 2,8 l/min. Duza max. 0,025"  
Presiune de lucru 227 bar, vascozitate medie - mare  
Pachet livrare standard: pompa, carucior, pistol airless, duza 517, 15m furtun airless 1/4", extensie pistol 45 cm, ulei de lubrifiere



BT1009391 **PAZ-32X Pompa airless cu piston pentru zugraveli/vopsitorii** 1.320

Motor electric 2.600W, alimentare 230V - 50 Hz  
Debit de lucru 3,2 l/min. Duza max. 0,031"  
Presiune de lucru 227 bar, vascozitate medie - mare  
Pachet livrare standard: pompa, carucior, 2 pistoale airless, 2 x duze 517, 15m furtun airless 1/4", extensie pistol 45 cm, ulei de lubrifiere  
Poate lucra cu 2 pistoale simultan



BT1009XXX **PAZ-51X Pompa airless cu piston pentru zugraveli/vopsitorii (fara cuva)** 1.840



Motor electric 3.000W, comanda EPC digital, alimentare 230V - 50 Hz  
Debit de lucru 5,1 l/min. Duza max. 0,037"  
Presiune de lucru 227 bar, vascozitate admisa mare  
Pachet livrare standard: 1 pistol airless, carucior, 2 x duze (525/531), 1 x 15m furtun airless 3/8", extensie pistol 45 cm, ulei de lubrifiere.







# Pompe airless pentru zugravit / vopsit

Cod produs

Descriere produs

Pret Euro (fara TVA)

BT1009392 **PAZ-81X Pompa airless cu piston pentru zugraveli/vopsitorii (fara cuva)** 2.490

Motor electric 4.500W, comanda EPC digital, alimentare 230V - 50 Hz

Debit de lucru 8,0 l/min. Duza max. 0,045"

Presiune de lucru 227 bar, vascozitate admisa mare

Pachet livrare standard: 2 pistoale airless, carucior, 3 x duze (525/535/541), 2 x 15m furtun airless 3/8", furtun 1/2-15m, furtun 3/8 - 1m, furtun 1/4 - 1m

Extensie pistol 45 cm, ulei de lubrifiere. Poate lucra cu 2 pistoale simultan



BT1009393 **Cuva material 60L** (include conector pentru pompa **PAZ-81X** si capac) 345

BT1009394 **Sistem presare/roluire saci** pentru evacuare materiale semifluide 165

(se conecteaza la rezervor)



BT1006390 **PAZ-9600e Pompa airless hidraulica** pentru vopsit / zugravit si gleturi lichide 4.915

Piston hidraulic angrenat de motor electric 6,7 kW - 400V, transmisie curea

Debit material 10 l/min., duza max. 0.056"

Presiune de lucru 228 bar, vascozitate admisa mare

Dotare standard: pistol airless cu duze airless 537 si 243, 15 m furtun 3/8", 1m furtun pentru manevrare 1/4"

Greutate echipament 89 kg; Dimensiuni 1.200x750x1.200 mm



BT0008069 **PAZ-9800e Pompa airless hidraulica** pentru vopsit / zugravit si gleturi lichide 3.044

Piston hidraulic angrenat de motor electric 3,75 kW, 230V, transmisie directa

Debit material 10 l/min, duza max. 0.041"

Presiune de lucru 220 bar, vascozitate admisa mare

Dotare standard: pistol airless cu duze 435 si 341, 15 m furtun 3/8", extensie pistol 50 cm, ulei lubrefiere

Greutate echipament 97 kg; Dimensiuni 1.080x660x1.020 mm



## POMPA AIRLESS CU MEMBRANA

6426390839602 **PAZ-6860e Pompa airless cu membrana pentru zugraveli/vopsitorii** 735

Motor electric 1.800W, alimentare 230V - 50 Hz

Debit de lucru 4 l/min. Granulometrie max. 0,5mm

Presiune de lucru 120 - 150 bar, vascozitate medie - mare

Dotare standard: pistol airless, duza, 15m furtun 1/4", kit reparatie, carucior transport



BT1009127 **PAZ-7000/2 Pompa airless cu membrana pentru zugraveli/vopsitorii** 1.490

Motor electric 3.000-3.200 W alimentare 230V-50Hz

Debit de lucru 7 l/min

Duza maxima 0.042", distanta max. de pompare 90m

Presiune de lucru 210bar, vascozitate admisa medie-mare

Dotare standard: pompa, carucior, 2 pistoale, 2 furtunuri x 15m, rezervor material din inox 20L, manometru

Poate lucra cu 2 pistoale simultan





# Pompe pentru spuma poliuretanică

Cod produs

Descriere produs

Pret Euro (fara TVA)

**Izolatii termice** pentru subsoluri case, blocuri, mansarde, hale industriale si agricole, etc.  
**Izolatii fonice** pentru hale industriale, apartamente, pereti case, baruri, restaurante, sali evenimente, etc.  
**Izolatii hidro** cu poliuree pentru cuve, bazine, piscine, balcoane, acoperisuri, etc.

Nota: Pompele Bisonte FA necesita compresor minim 1.000 l/min. cu uscator. Compresorul cu uscator este necesar pentru eliminarea condensului care ar putea bloca partea pneumatica de la sistemul de pompare si totodata, pentru ca respectivul condens sa nu intre in contact cu spuma.



BT1002855 **FA50 Pompa pentru spuma poliuretanică** 9.933

Rata de amestec 1:1 sau 2:1, Presiune max. 200 bar  
 Volum max. de lucru 9,5 kg/min.  
 Lungime max. furtunuri 90 m, (se livreaza cu 15m)  
 Putere echipament 10,5 kW, incalzire 6 x 1 kW,  
 Incalzire furtun 3,5 kW  
 Alimentare 400V, greutate 210 kg

BT0006074 **Furtunuri 5 in 1 pentru pompa FA50** 1.203  
 include 2 furtunuri material + 2 furtunuri aer si cablu electric.

BT0002848 **Pistol FA50** pentru Spuma poliuretanică 1.097

BT0004040 Duza pistol 1,3 mm 30,0

BT0004141 Duza pistol 1,6 mm 34,2

BT0004142 Duza pistol 1,8 mm 34,2

BT0004143 Duza pistol 2,0 mm 34,2



BT1008030 **FA60 Pompa pentru spuma poliuretanică si poliuree** 11.367

Rata de amestec 1:1 sau 2:1, Presiune max. 200 bar  
 Volum max. de lucru 9,5 kg/min.  
 Lungime max. furtunuri 90 m (se livreaza cu 15m)  
 Putere echipament 16 kW, incalzire 2 x 6 kW,  
 incalzire furtun 3,0 kW  
 Alimentare 400V, greutate 210 kg

BT0008351 **Furtunuri 5 in 1 pentru pompa FA60** 1.203  
 include 2 furtunuri material + 2 furtunuri aer si cablu electric.

BT0008416 **Pistol FA60** pentru Spuma poliuretanică si poliuree 1.872

BT0004040 Duza pistol 1,3 mm 30,0

BT0004041 Duza pistol 1,6 mm 24,0

BT0004042 Duza pistol 1,8 mm 24,0

BT0004043 Duza pistol 2,0 mm 24,0



RT1008405 **Compresor cu surub Rotair EN07 si uscator inclus - compatibil cu pompele FA50/FA60** 5.789

Debit aer: 1.100 l/min.  
 Presiune de lucru: 7 bar  
 Rezervor aer: 270 l  
 Motor electric: 7,5 kW, 400V





# Accesorii pentru pompele airless

Cod produs

Descriere produs

Pret Euro (fara TVA)



## Pistoale airless

BT0008570 Pistol pentru pompa sistem Airless, filtru interior maner (fig.1)  
Include duza 517; Presiune maxima 270 bar

76,3



BT6376G500 Pistol pentru pompa sistem Airless, nu necesita filtru interior maner (fig.2)  
Include duza 517; Presiune maxima 500 bar

66,0

fig. 2

BT0002028 Pistol pentru pompa sistem Airless, filtru interior maner (fig.3)  
Permite reglarea unghiului de spraiere pe verticala  
Include duza 517; Presiune maxima 270 bar

72,9

fig. 3

BT0008827 Pistol pentru PAZ9600 - 9800, nu necesita filtru (fig.4)  
Include duza 535; Presiune maxima 500 bar

98,8

fig. 4

BT0002038 Garda de protectie duza presiune max. 345 bar

14,1



## Duze airless

BT2000xxx Duza reversibila 211, 213, 311, 313, 315, 317, 411, 511, 513, 515, 517, 519, 521, 523, 525, 527, 529, 531, 533, 535, 543

12,8

BT0002031 Garnitura pentru mufa-duza (din oțel inoxidabil + nylon)

1,9



## Filtre pistol

BT3002034 Filtru verde pentru maner pistol in sistem Airless 30 microni

2,4

BT3002123 Filtru alb pentru maner pistol in sistem Airless 50 microni

2,4

BT3001994 Filtru galben pentru maner pistol in sistem Airless 100 microni

2,4

BT3005000 Filtru rosu pentru maner pistol in sistem Airless 150 microni

2,4



## Extensie pentru pistoale de vopsit in sistem Airless

BT0002035 Lungime 30 cm

8,6

BT0002036 Lungime 50 cm

10,3

BT0003324 Lungime 75 cm

14,4

BT0002037 Lungime 100 cm

16,0





# Accesorii pentru pompele airless

Cod produs	Descriere produs	Pret Euro (fara TVA)
------------	------------------	----------------------

## Filtre pentru corp pompa sau aspiratie material

BT0004963	Filtru aspiratie PAZ6321/PAZ6325	8,3
BT0004978	Filtru fin aspiratie PAZ6335/PAZ6336IB filet 3/4	12,2
BTX96226	Filtru aspiratie PAZ9600	17,9
BTX98226	Filtru aspiratie PAZ9800	11,8
BT0004974	Filtru corp pompa PAZ6336IB	6,1
BT0005736	Filtru grosier aspiratie PAZ6335/PAZ6336	12,4
BT0004959	Filtru corp pompa PAZ6321/PAZ6325	6,1
BT0005739	Filtru corp pompa PAZ6335/PAZ6331	3,3
BT0008605	Filtru aspiratie model nou PAZ6860	18,3



## Furtunuri de mare presiune pentru zugraveli/vopsitorii in sistem Airless

BT0002039	1/4" cu 15 m lungime, max. 280 bar	35,0
BT0002040	1/4" cu 30 m lungime, max. 280 bar	72,0



## Conectori pentru prelungire furtun cu diametru de:

BT0002041	1/4"-1/4";	2,3
BT0005774	3/8"-3/8";	4,3
BT0005773	1/4"- 3/8";	3,6



BT0003326	Conector cu rotire 360 °, pentru pistol sau extensie in sistem Airless	20,0
BT0002042	Conector pivotant liber, pentru furtun pompa in sistem Airless	23,3



BT0005837	Ghidaj pentru vopsire colturi	26,0
-----------	-------------------------------	------



RO0006026	Ulei pentru lubrifiere piston 240 ml	8,2
RO0009471	<b>MF32</b> Ulei pentru lubrifierea pistoanelor la pompele airless 450 ml	14,0





# Slefuire pereti - tavan / Aspiratoare

Cod produs	Descriere produs	Pret Euro (fara TVA)
3533254132915	<b>SP-3000 Slefuitor cu maner telescopic, sac si sistem colectare praf</b> Putere motor: 800W; 230V - 50Hz Nr. rotatii disc: 800 - 1.700 rpm, diametru disc slefuire 225 mm Lungime reglabila a manerului: 140 - 180 mm Lumina de lucru Greutate: 5,8 kg	125
BT1008845	<b>SP-3001CC Slefuitor cu maner telescopic, pad rotund si triunghiular</b> Putere motor: 710W, 230V - 50 Hz Numar rotatii disc: 800 - 1.700 /min; 3.000 - 6.000 /min. Diametru disc slefuire: 225 mm Greutate: 3,9 kg Se livreaza in cutie de carton	155
3533254132922	<b>SP-3001GP Slefuitor cu maner telescopic, pad rotund si triunghiular</b> Putere motor: 710W, 230V - 50 Hz Numar rotatii disc: 800 - 1.700 /min; 3.000 - 6.000 /min. Diametru disc slefuire: 225 mm Greutate: 3,9 kg Se livreaza in cutie plastic pentru depozitare si transport	165
	<b>Set 6 buc. granulometrie la alegere din 60/80/120/150/180/240</b>	
BT3000xxx	<b>Set discuri smirghel diam. 225 mm pentru SP3000 si SP3001</b>	3,8
BT3001xxx	<b>Set smirghel in triunghi pentru SP3001</b>	3,8
BT300xxxx	<b>Set discuri smirghel diam. 225mm pentru SP900 si SP901</b>	5,7
BT300xxxx	<b>Set smirghel in triunghi pentru SP901</b>	5,7
	<b>Aspiratoare de santier</b>	
BT1005836	<b>AS-506 Aspirator</b> Putere motor 1,4 kW - 230V, capacitate 20+18 litri, clasa 1 insonorizare	148
6426390839893	<b>AS-501 Aspirator</b> Putere motor 1.6 kW - 230 , capacitate 30 l, putere aspirare >0.18 bar	278
BT1008458	<b>AS-750 Aspirator</b> Putere motor 0.75 kW - 230V, Volum recipient 70 l, debit aer 3.5 mc/min. Turatie reglabila 6.000 - 15.000 rpm Greutate 1.9 kg; Dimensiuni 320x230x220 mm	59,0

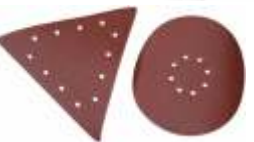



# Malaxoare / Gletiere / Picioroange

Cod produs

Descriere produs

Pret Euro (fara TVA)

## Malaxoare electrice

3533254132885 **M207A Mixer** pentru vopsele, 1250W, 230V

3533254132892 **M208B Mixer** pentru vopsele, 1400W, 230V, 2 viteze

3533254132908 **M210B Mixer** pentru vopsele si gleturi 1800W, 230V, 2 viteze



69,0

91,5

116

## Gletiere manuale profesionale

BT0009251 WSB-20 Gletiera profesionala latime 200 mm

BT0009252 WSB-30 Gletiera profesionala latime 300 mm

BT0009253 WSB-55 Gletiera profesionala latime 550 mm

7403284154972 WSB-80 Gletiera profesionala latime 800 mm

BT0009254 WSB-120 Gletiera profesionala latime 1.200 mm



10,8

12,7

19,9

28,0

39,9



BT0009255 Maner pentru gletiera profesionala WSB 20/30/55/80/120

BT0009256 Prelungitor telescopic pentru gletiera profesionala WSB 20/30/55/80/120

10,8

16,4

Maner, prelungitor si gletiera

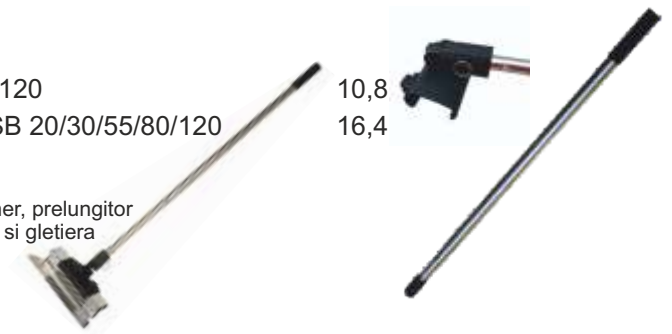

## Picioroange profesionale

BT0005510 Picioroange profesionale 60 cm

BT0005511 Picioroange profesionale 100 cm

BT0005509 Picioroange profesionale 160 cm

153

162

223





# Compressoare electrice cu piston

Cod produs

Descriere produs

Pret Euro (fara TVA)

## Compressoare aer cu piston fara ulei, transmisie directa

3533254132762

### SC008-009, debit aer 94 l/min., presiune operare 8 bar

119

Volum rezervor aer 9 litri;  
Motor electric 230V - 0.55 kW, turatie 1480 rpm;  
Greutate 16 kg;  
Dimensiuni 480x150x490 mm



3533254132779

### SC012-025, debit aer 168 l/min., presiune operare 8 bar

158

Volum rezervor aer 25 l;  
Motor electric 230V - 0.85 kW, turatie 1480 rpm;  
Greutate 23 kg;  
Dimensiuni 540x260x575 mm



6426390839671

### SC012-050, debit aer 168 l/min., presiune operare 8 bar

164

Volum rezervor aer 50 l;  
Motor electric 230V - 0.85 kW, turatie 1480 rpm;  
Greutate 25 kg;  
Dimensiuni 680x320x640 mm



3533254132786

### SC012-015, debit aer 168 l/min., presiune operare 8 bar

223

Volum rezervor aer 15 l;  
Motor electric 230V - 0.85 kW, turatie 1480 rpm;  
Greutate 23 kg;  
Dimensiuni 620x420x395 mm



3533254132793

### SC024-100, debit aer 336 l/min., presiune operare 8 bar

336

Volum rezervor aer 100 l;  
2 motoare electrice 230V - 2 x 0.85 kW, turatie 1480 rpm;  
Greutate 50 kg;  
Dimensiuni 1.000x360x680 mm



3533254132809

### SC020-015, debit aer 206 l/min., presiune operare 8 bar

282

Volum rezervor aer 15 l;  
Motor electric 230V - 1.5 kW, turatie 1480 rpm;  
Greutate 32 kg;  
Dimensiuni 620x420x395 mm





# Compressoare electrice cu piston

Cod produs

Descriere produs

Pret Euro (fara TVA)

## Compressoare aer cu piston cu ulei, transmisie directa

3533254132816

### SF020-025, debit aer 187 l/min., presiune operare 8 bar

137

Volum rezervor aer 25 l;  
Motor electric 230V - 1.5 kW, turatie 2840 rpm;  
Greutate 23 kg;  
Dimensiuni 565x245x530 mm



3533254132823

### SF020-050, debit aer 187 l/min., presiune operare 8 bar

162

Volum rezervor aer 50 l;  
Motor electric 230V - 1.5 kW, turatie 2840 rpm;  
Greutate 23 kg;  
Dimensiuni 690x335x605 mm



3533254132830

### SF020-100, debit aer 187 l/min., presiune operare 8 bar

239

Volum rezervor aer 100 l;  
Motor electric 230V - 1.5 kW, turatie 2840 rpm;  
Greutate 43 kg;  
Dimensiuni 1.000x360x720 mm



## Compresor aer cu piston cu ulei, transmisie pe curea

3533254132847

### SV054-105, debit aer 786 l/min., presiune operare 8 bar

677

Volum rezervor aer 105 litri;  
Motor electric 230V - 4.0 kW, turatie 1030 rpm;  
Greutate 112 kg;  
Dimensiuni 1.280x560x1.020 mm



3533254132854

### SW102-170, debit aer 1.179 l/min., presiune operare 8 bar

790

Volum rezervor aer 170 litri;  
Motor electric 230V - 7.5 kW, turatie 1050 rpm;  
Greutate 160 kg;  
Dimensiuni 1.530x606x1.040 mm



RO0009474 KA95 Ulei mineral aditivat pentru compresoarele de aer cu piston 1L



4,95





# Aparate de sudura tip inverter

Cod produs	Descriere produs	Pret Euro (fara TVA)
------------	------------------	----------------------

## Sudura MMA

3533254132861	<b>MMA-160</b> , curent sudura 10 - 160A, electrod 1.6 - 3.2 mm	144
---------------	---	-----

Tehnologie sudura: IGBT inverter; Tensiune in gol 96V  
Curent nominal 160A; Tensiune nominala 26.4V; Voltaj: 230V; Putere 5.5 kW  
Eficienta 85%; Regim nominal 60%  
Greutate 5.4 kg; Dimensiuni 450x270x345 mm

**Echipare standard:** Clesti suport electrod si masa, masca sudura si perie/ciocanel pentru zgura



6426390839879	<b>MMA-200</b> , curent sudura 10 - 200A, electrod 1.6 - 4 mm	169
---------------	---	-----

Tehnologie sudura: IGBT inverter; Tensiune in gol 104V  
Curent nominal 200A; Tensiune nominala 27.2V; Voltaj 230V; Putere 6.5 kW  
Eficienta 85%; Regim nominal 60%  
Greutate 6.0 kg; Dimensiuni 450x270x345 mm

**Echipare standard:** Clesti suport electrod si masa, masca sudura si perie/ciocanel pentru zgura



6426390839923	<b>MMA-300-230V</b> , curent sudura 10 - 300A, electrod 1.6 - 5 mm	223
---------------	--	-----

Tehnologie sudura: IGBT inverter; Tensiune in gol 110V  
Curent nominal 300A; Tensiune nominala 27.2V; Voltaj: 230V; Putere 9.5 kW  
Eficienta 85%; Regim nominal 60%  
Greutate 9.4 kg; Dimensiuni 505x270x410 mm

**Echipare standard:** Clesti suport electrod si masa, masca sudura si perie/ciocanel pentru zgura



6426390839930	<b>MMA-300-400V</b> , curent sudura 10 - 300A, electrod 1.6 - 5 mm	212
---------------	--	-----

Idem MMA300-230V, Tensiune nominala 29.6V; Voltaj 400V; Putere 9.5 kW

## Sudura TIG si MMA

6426390839947	<b>TIG-250</b> , curent sudura 15 - 250A, electrod 1 - 3 mm	242
---------------	---	-----

Tehnologie sudura: IGBT inverter de inalta tensiune; Tensiune in gol 52V  
Tensiune iesire 160V; Tensiune nominala 250A / 17.6V  
Eficienta 85%; Regim nominal 60%  
Plaja reglare intarziere gaz 0 - 5 secunde  
Factor de putere 0.7

Greutate 6.5 kg; Dimensiuni 450x270x345 mm

**Echipare standard:** Clesti suport electrod si masa, masca sudura si perie/ciocanel pentru zgura, pistol tig complet, 2 duze ceramica si pensete



6426390839954	<b>TIG-300</b> , curent sudura 15 - 300A, electrod 1 - 3 mm	320
---------------	---	-----

Tehnologie sudura: IGBT inverter de inalta tensiune; Tensiune in gol 65V  
Curent nominal 180V; Tensiune nominala 300A; Voltaj: 400V; Putere 19.2V  
Eficienta 85%; Regim nominal 60%  
Plaja reglare intarziere gaz 0 - 5 secunde  
Factor de putere 0.75

Greutate 10 kg; Dimensiuni 505x270x410 mm

**Echipare standard:** Clesti suport electrod si masa, masca sudura si perie/ciocanel pentru zgura, pistol tig complet, 2 duze ceramica si pensete



## Electrod sudura MMA otel carbon, pret / 1kg, comanda minima 5kg

BT0009013	Electrod sudura E4303/J422; Ø2.5 mm, lungime 300mm, 60-85 A	4,4
-----------	---	-----

BT0009014	Electrod sudura E4303/J422 Ø3.2 mm, lungime 350 mm, 85-120 A	4,4
-----------	--	-----

BT0009015	Electrod sudura E4303/J422 Ø4.0 mm, lungime 400 mm, 115-150 A	4,4
-----------	---	-----





# Taiere cu plasma

Cod produs	Descriere produs	Pret Euro (fara TVA)
6426390839961	<b>CUT-40</b> , Curent iesire 10 - 40A, grosime taiere 1 - 10 mm Tehnologie inverter IGBT Voltaj 230V; Tensiune in gol 270V; Tensiune iesire 96V Eficienta 85%; Regim nominal 60%; Factor de putere 0.7 Presiune de aer recomandata 3 - 4 bar Greutate 7 kg; Dimensiuni 450x270x345 mm <b>Echipare standard:</b> Cablu cu cleste pentru masa; mască de sudură cu sticlă; perie și ciocănel pentru zgură; pistol CUT complet; manometru presiune; filtru aer comprimat; accesorii conectare compresor	225
6426390839978	<b>CUT-60</b> , Curent iesire 10 - 60A, grosime taiere 1 - 15 mm Tehnologie inverter IGBT Voltaj 400V; Tensiune in gol 270V; Tensiune iesire 104V Eficienta 85%; Regim nominal 60%; Factor de putere 0.75 Presiune de aer recomandata 4-5 bar Greutate 11,3 kg; Dimensiuni 505x270x410 mm <b>Echipare standard:</b> Cablu cu cleste pentru masa; mască de sudură cu sticlă; perie și ciocănel pentru zgură; pistol CUT complet; manometru presiune; filtru aer comprimat; accesorii conectare compresor	319
6426390839985	<b>CUT-80</b> , Curent iesire 20 - 75A, grosime taiere 1 - 25 mm Tehnologie inverter IGBT Voltaj 400V; Tensiune in gol 280V; Tensiune iesire 110V Presiune de aer recomandata 4-5 bar Eficienta 85%; Regim nominal 60%; Factor de putere 0.75 Greutate 21 kg; Dimensiuni 585x375x500 mm <b>Echipare standard:</b> Cablu cu cleste pentru masa; mască de sudură cu sticlă; perie și ciocănel pentru zgură; pistol CUT complet; manometru presiune; filtru aer comprimat; accesorii conectare compresor	504
3533254132878	<b>CUT-100</b> , Curent iesire 20 - 100A, grosime taiere 1 - 40 mm Tehnologie inverter IGBT Voltaj 400V; Tensiune in gol 300V; Tensiune iesire 120V Eficienta 85%; Regim nominal 60%; Factor de putere 0.75 Presiune de aer recomandata 4-6 bar Greutate 29.2 kg; Dimensiuni 624x415x530 mm <b>Echipare standard:</b> Cablu cu cleste pentru masa; mască de sudură cu sticlă; perie și ciocănel pentru zgură; pistol CUT complet; manometru presiune; filtru aer comprimat; accesorii conectare compresor	664
6426390839213	<b>CUT-120</b> , Curent iesire 20 - 120A, grosime taiere 1 - 45 mm Tehnologie inverter IGBT Voltaj 400V; Tensiune in gol 310V; Tensiune iesire 128V Eficienta 85%; Regim nominal 60%; Factor de putere 0.75 Presiune de aer recomandata 4-6 bar Greutate 31.5 kg; Dimensiuni 624x415x530 mm <b>Echipare standard:</b> Cablu cu cleste pentru masa; mască de sudură cu sticlă; perie și ciocănel pentru zgură; pistol CUT complet; manometru presiune; filtru aer comprimat; accesorii conectare compresor	786



Cod produs

Descriere produs

Pret Euro (fara TVA)

## Scara simpla aluminiu

BT1006294	STR109 Scara simpla 9 trepte, 2,53 m aluminiu	66,2
BT1006295	STR111 Scara simpla 11 trepte, 3 m aluminiu	42
BT1006296	STR113 Scara simpla 13 trepte, 3,59 m aluminiu	78,7
BT1006297	STR115 Scara simpla 15 trepte, 4,13 m aluminiu	97,3

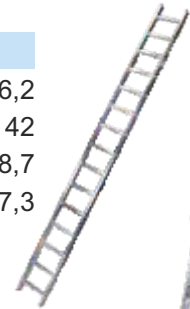

## Scara dubla aluminiu

BT1006298	STR207 Scara dubla aluminiu 2x7 trepte, inaltime scara dubla 1,86 m	63,3
BT1006299	STR209 Scara dubla aluminiu 2x9 trepte, inaltime scara dubla 2,4 m	83,3
BT1006300	STR211 Scara dubla aluminiu 2x11 trepte, inaltime scara dubla 3 m	109
BT1006301	STR214 Scara dubla aluminiu 2x14 trepte, inaltime scara dubla 3,86 m	137
BT1006302	STR217 Scara dubla aluminiu 2x17 trepte, inaltime scara dubla 4,67 m	120



## Scara tripla aluminiu

BT1006303	STR307 Scara tripla 7 trepte, 1,98 m aluminiu	76,9
BT1006304	STR308 Scara tripla 8 trepte, 2,25 m aluminiu	113
BT1006305	STR309 Scara tripla 9 trepte, 2,53 m aluminiu	133
BT1006306	STR311 Scara tripla 11 trepte, 3 m aluminiu	117
BT1006307	STR313 Scara tripla 13 trepte, 3,59 m aluminiu	190
BT1006308	STR315 Scara tripla 15 trepte, 4,13 m aluminiu	222



## Scara multifunctionala 4 segmente

BT1006279	STR402 Scara multifunctionala din aluminiu 4 segmente x 2 trepte, 2,5 m	84
BT1006280	STR403 Scara multifunctionala din aluminiu 4 segmente x 3 trepte, 3,6 m	98,9
3533254132939	STR404 Scara multifunctionala din aluminiu 4 segmente x 4 trepte, 4,6 m	75,1
BT1006282	STR405 Scara multifunctionala din aluminiu 4 segmente x 5 trepte, 5,8 m	128



## Schela cu scara dubla aluminiu

BT1006309	STR0505 Schela cu scara dubla aluminiu 1,4 m	111
BT1006310	STR0507 Schela cu scara dubla aluminiu 1,96 m	144





# Scari universale si pentru interior

Cod produs	Descriere produs	Pret Euro (fara TVA)
<b>Scara telescopica aluminiu</b>		
BT1006283	STR1020 Scara telescopica aluminiu, 7 trepte, 2 m	46,2
BT1006284	STR1026 Scara telescopica aluminiu, 9 trepte, 2,6 m	60
3533254132953	STR1032 Scara telescopica aluminiu, 11 trepte, 3,2 m	90,7
3533254132960	STR1038 Scara telescopica aluminiu, 13 trepte, 3,8 m	106
<b>Scara telescopica dubla aluminiu</b>		
BT1006287	STR3032 Scara telescopica dubla aluminiu, 2x5 trepte, inaltime scara dubla 1,56 m	113
<b>Scara aluminiu pentru interior</b>		
BT1006288	STR0102 Scara aluminiu 2 trepte, 0,92 m pentru interior	27,8
3533254132946	STR0104 Scara aluminiu 4 trepte, 1,32 m pentru interior	38,9
BT1006290	STR0106 Scara aluminiu 6 trepte, 1,7 m pentru interior	57,3
<b>Scara otel pentru interior</b>		
BT1006291	STR0202 Scara otel 2 trepte, 52 cm pentru interior	27,3
BT1009010	STR0203 Scara otel 3 trepte, pentru interior	25,6
BT1006292	STR0204 Scara otel 4 trepte, 104 cm pentru interior	44,0
BT1006293	STR0206 Scara otel 6 trepte, 156 cm pentru interior	55,1







# Masini de carotat

Cod produs	Descriere produs	Pret Euro (fara TVA)
BT1006275	<b>EC1500</b> Masina de carotat, 1.500W, diam. carota max. beton Ø80 mm Carota max. zidarie Ø200 mm / beton Ø80 mm Turatie motor in prima treapta 950 rpm, treapta 2 = 2.100 rpm Include coloana cu cremaliera Greutate echipament: 19 kg	390
BT1006276	<b>EC2800</b> Masina de carotat, 2.800W, diam. carota max. beton Ø255 mm Carota max. zidarie Ø400 mm / beton Ø255 mm Turatie motor in prima treapta 500 rpm, treapta 2 = 920 rpm Include coloana cu cremaliera Greutate echipament 27 kg	985
BT1006277	<b>EC3000</b> Masina de carotat, 2.800W, diam. carota max. beton Ø300 mm Carota max. zidarie Ø500 mm / beton Ø300 mm Turatie motor in prima treapta 500 rpm, treapta 2 = 920 rpm Include coloana cu cremaliera Greutate echipament: 27,3 kg	1.070
BT2000545	Carota diamantata <b>42x400 mm</b> prindere 1 ¼" UNC	22,9
BT2000546	Carota diamantata <b>50x400 mm</b> prindere 1 ¼" UNC	25,6
BT2007212	Carota diamantata <b>83x400 mm</b> prindere 1 ¼" UNC	38,7
BT2000547	Carota diamantata <b>102x400 mm</b> prindere 1 ¼" UNC	51,0
BT2008788	Carota diamantata <b>112x400 mm</b> prindere 1 ¼" UNC	56,3
BT2000548	Carota diamantata <b>120x400 mm</b> prindere 1 ¼" UNC	52,5
BT2000549	Carota diamantata <b>127x400 mm</b> prindere 1 ¼" UNC	62,8
BT2000550	Carota diamantata <b>132x400 mm</b> prindere 1 ¼" UNC	68,3
BT2000559	Carota diamantata <b>152x400 mm</b> prindere 1 ¼" UNC	77,2
BT2000560	Carota diamantata <b>159x400 mm</b> prindere 1 ¼" UNC	81,4
BT2000561	Carota diamantata <b>166x400 mm</b> prindere 1 ¼" UNC	84,3
BT2000562	Carota diamantata <b>180x400 mm</b> prindere 1 ¼" UNC	94,2
BT2000551	Carota diamantata <b>202x400 mm</b> prindere 1 ¼" UNC	134
BT2000552	Carota diamantata <b>254x400 mm</b> prindere 1 ¼" UNC	190
BT2000553	Carota diamantata <b>300x400 mm</b> prindere 1 ¼" UNC	243
BT2000554	Carota diamantata <b>350x400 mm</b> prindere 1 ¼" UNC	291
BT2000555	Carota diamantata <b>400x400 mm</b> prindere 1 ¼" UNC	433
BT2000556	Carota diamantata <b>450x400 mm</b> prindere 1 ¼" UNC	560
BT2000557	Carota diamantata <b>500x400 mm</b> prindere 1 ¼" UNC	629





# Generatoare de curent OPEN

Cod produs	Descriere produs	Pret Euro (fara TVA)	
7403284155023	<b>SK2500</b> Putere max. 2,2kW, 230V-50Hz, AVR, Motor benzina 7 cp Rezervor carburant 15L; Autonomie 11 ore - 100% consum Contor ore/voltmetru/frecventa; Senzor lipsa ulei cu led rosu si oprire motor; Demaraj la sfoara Greutate: 41,3kg; Dimensiuni: 589x438x450 mm	251	
7403284155030	<b>SK2800</b> Putere max. 2,8kW, 230V-50Hz, AVR, Motor benzina 7 cp Rezervor carburant 15L; Autonomie 10 ore - 100% consum Contor ore/voltmetru/frecventa; Senzor lipsa ulei cu led rosu si oprire motor; Demaraj la sfoara Greutate: 41,7kg; Dimensiuni: 589x438x450 mm	256	
7403284155047	<b>SK4500</b> Putere max. 3,8kW, 230V-50Hz, AVR, Motor benzina 7,5 cp Rezervor carburant 15L; Autonomie 8 ore - 100% consum Contor ore/voltmetru/frecventa; Senzor lipsa ulei cu led rosu si oprire motor; Demaraj la sfoara Greutate: 46,5kg; Dimensiuni: 589x438x450 mm	314	
7403284155054	<b>SK5000E</b> Putere max. 4,8kW, 230V-50Hz, AVR, Motor benzina 14 cp Rezervor carburant 25L; Autonomie 7,5 ore - 100% consum Contor ore/voltmetru/frecventa; Senzor lipsa ulei cu led rosu si oprire motor; Demaraj electric Roti si manere pentru transport incluse Greutate: 76,5kg; Dimensiuni: 683x515x545 mm	528	
7403284155061	<b>SK5000E</b> Putere max. 5,5kW, 230V-50Hz, AVR, Motor benzina 14 cp Rezervor carburant 25L; Autonomie 7 ore - 100% consum Contor ore/voltmetru/frecventa; Senzor lipsa ulei cu led rosu si oprire motor; Demaraj electric Roti si manere pentru transport incluse Greutate: 80,3kg; Dimensiuni: 683x515x545 mm	534	
7403284155078	<b>SK10000E</b> Putere max. 8kW, 230V-50Hz, AVR, Motor benzina 16 cp Rezervor carburant 25L; Autonomie 5 ore - 100% consum Contor ore/voltmetru/frecventa; Senzor lipsa ulei cu led rosu si oprire motor; Demaraj electric Roti si manere pentru transport incluse Greutate: 89,7kg; Dimensiuni: 683x515x545 mm	655	
BT0004370	Ulei motor pe benzina, Italia Star 10W-40 fabricat in Romania, bidon 1L	5,4	

# BISONTE AGRO



**Motocultoare**  
Pagina 49



**Masini multifunctionale**  
Pagina 52



**Remorci pentru motocultoare**  
Pagina 54



**Motoburghie**  
Pagina 54



**Trenchere (sapare santuri)**  
Pagina 54



**Motopompe si furtunuri absorbție**  
Pagina 55



**Masini si tractoare de tuns iarba**  
Pagina 57



**Atomizoare**  
Pagina 58



**Aparate de spalat cu presiune**  
Pagina 58



**Despicatoare lemne**  
Pagina 59









**Tocatoare crengi**  
Pagina 59







# Motocultoare

Cod produs	Descriere produs	Pret Euro (fara TVA)	
BT6000026	<b>Motosapa BTA-MT430Y</b> motor in 2 timpi 1,8 CP, 42.7 cmc, 8.000 rpm, latime lucru 235mm. Demaror cu recul, aprindere cu scanteie, ambreiaj centrifugal Raport benzina/ulei 40:1. Raport transmisie 32:1 Greutate netă 18,2 kg, dim. ambalaj: 540 x 300 x 550 mm	200	
3161304182339	<b>Motocultor BTA-750</b> fara cover, motor 170F 212 cmc, benzina, 7CP, transmisie curea, corp aluminiu, roti 4.00-8 SET LIVRARE 2 x Roată de cauciuc 4.00-8 / 40 cm 1 x Set două freze segmentabile 30 cm, 2+1 1 x Suport fix pentru accesorii 1 x Tijă reglare adâncime 2 x Manicot (tub hexagonal) Ø23 mm, 4 găuri Greutate bruta 79 Kg, dim. ambalaj 740x420x825mm	342	
7403284155146	<b>Motocultor BTA-750-1</b> (cover) Idem	408	
BT6000042	<b>Motocultor BTA-750FR</b> (fara roti) Idem	325	
7403284155153	<b>Motocultor BTA-900</b> cover, motor 170F 212 cmc, benzina, 7CP, transmisie curea, corp fonta, roti 5.00-8 SET LIVRARE 2 x Roată de cauciuc 5.00-8 / 40 cm 1 x Set două freze segmentabile 30 cm, 2+1 1 x Suport fix pentru accesorii 1 x Tijă reglare adâncime 2 x Manicot (tub hexagonal) Ø23 mm, 4 găuri Greutate bruta 93 Kg, dim. ambalaj 740x420x825mm	427	
BT6000043	<b>Motocultor BTA-900FC</b> (fara cover) Idem	410	
7403284155092	<b>Motocultor BTA-1000</b> cover, motor 170F 212 cmc, benzina, 7CP, cutie de viteze, corp fonta, roti 5.00-8 SET LIVRARE 2 x Roată de cauciuc 5.00-8 / 40 cm 1 x Set două freze segmentabile 30 cm, 2+1 1 x Suport fix pentru accesorii 1 x Tijă reglare adâncime 2 x Manicot (tub hexagonal) Ø23 mm, 4 găuri Greutate bruta 89 Kg, dim. ambalaj 840x550x655mm	435	
BT6000044	<b>Motocultor BTA-1000FC</b> (fara cover) Idem	411	
BT6000057	<b>Motocultor BTA-1000FC-HLS</b> (fara cover) Idem. Dotat cu reductor.	480	
			
BT6000056	<b>Motocultor BTA-1000FC-DIF</b> (fara cover) Idem. Dotat cu diferential si reductor	540	
			



# Motocultoare

Cod  
produs

Descriere produs

Pret Euro  
(fara TVA)

7403284155108 **Motocultor BTA-10SG** cover, motor 177F 300 cmc, benzina, 10CP, 559

cutie de viteze, corp fonta, roti 5.00-12  
SET LIVRARE  
2 x Roată de cauciuc 5.00-12  
1 x Set două freze segmentabile 30 cm, 2+2+1  
1 x Suport fix pentru accesorii  
1 x Tijă reglare adâncime  
2 x Manicot (tub hexagonal)  $\Phi$ 32 mm, 4 găuri  
Greutate bruta 140 Kg, dim. ambalaj 1.075x570x840mm



BT6000009 **Motocultor BTA-13SG** cover, motor 188F 389 cmc, benzina, 13CP, 685

cutie de viteze, corp fonta, roti 5.00-12  
SET LIVRARE  
2 x Roată de cauciuc 5.00-12  
1 x Set două freze segmentabile 30 cm, 2+2+1  
1 x Suport fix pentru accesorii  
1 x Tijă reglare adâncime  
2 x Manicot (tub hexagonal)  $\Phi$ 32 mm, 4 găuri  
Greutate bruta 145 Kg, dim. ambalaj 1.075x570x840mm



BT6000010 **Motocultor BTA-16SG** cover, motor 190F 420 cmc, benzina, 16CP, 725

cutie de viteze, corp fonta, roti 5.00-12  
SET LIVRARE  
2 x Roată de cauciuc 5.00-12  
1 x Set două freze segmentabile 30 cm, 2+2+1  
1 x Suport fix pentru accesorii  
1 x Tijă reglare adâncime  
2 x Manicot (tub hexagonal)  $\Phi$ 32 mm, 4 găuri  
Greutate bruta 150 Kg, dim. ambalaj 1.075x570x840mm



BT6000011 **Motocultor BTA-16SGE** cover, motor 190F 420 cmc, benzina, 16CP, 881

cutie de viteze, corp fonta, roti 5.00-12, demaror electric cu pornire la cheie -  
baterie inclusa  
SET LIVRARE  
2 x Roată de cauciuc 5.00-12  
1 x Set două freze segmentabile 30 cm, 2+2+1  
1 x Suport fix pentru accesorii  
1 x Tijă reglare adâncime  
2 x Manicot (tub hexagonal)  $\Phi$ 32 mm, 4 găuri  
Greutate bruta 150 Kg, dim. ambalaj 1.075x570x840mm



7403284155115 **Motocultor BTA-12SDE** cover, motor SC188F 438 cmc, diesel, 12CP, 1039

cutie de viteze, corp fonta, roti 5.00-12, demaror electric cu pornire la cheie -  
baterie inclusa  
SET LIVRARE  
2 x Roată de cauciuc 5.00-12  
1 x Set două freze segmentabile 30 cm, 2+2+1  
1 x Suport fix pentru accesorii  
1 x Tijă reglare adâncime  
2 x Manicot (tub hexagonal)  $\Phi$ 32 mm, 4 găuri  
Greutate bruta 180 Kg, dim. ambalaj 1.075x570x840mm





# Accesorii motocultoare

Cod produs	Descriere produs	Pret Euro (fara TVA)
BT7000114	Plug arat simplu (1)	28,1
BT7000115	Plug bilonat ajustabil (2)	39,2
BT7000116	Plug scos cartofi (3)	30,9
BT7000122	Plug arat reversibil mare (4)	126
BT7000117	Bilonator (5)	26
BT7000118	Roata metalica 4.00-8 (6)	43,3
BT7000119	Roata metalica 5.00-12 (7)	68
BT7000120	Tub hexagonal 23 mm (8)	4,5
BT7000121	Tub hexagonal 32 mm (9)	6
BT7000123	Freza completa 23 mm (10)	82,2
BT7000124	Freza completa 32 mm (11)	148
BT7000125	Cutit stanga 23 mm (12)	2,4
BT7000126	Cutit dreapta 23 mm (12)	2,4
BT7000129	Limitator adancime (13)	9,3
BT7000130	Suport pentru accesorii (14)	11,2
BT7000131	Roata cauciuc 4.00-8 (15)	16,8
BT7000132	Roata cauciuc 5.00-8 (15)	23
BT7000133	Roata cauciuc 5.00-12 (15)	42,4
BT7000134	Camera 4.00-8 (16)	2
BT7000135	Camera 5.00-8 (16)	4,7
BT7000136	Camera 5.00-12 (16)	4,5
BT7000137	Anvelopa 4.00-8 (17)	10,3
BT7000138	Anvelopa 5.00-8 (17)	15
BT7000139	Anvelopa 5.00-12 (17)	28
BT7000140	Bolt cu siguranta 8 x 45 mm (18)	0,2
BT0002384	Contor ore functionare motor benzina 4 timp	15,4
BT0004370	Ulei motor pe benzina, Italia Star 10W-40, fabricat in Romania	5,4
BT0009179	Ulei transmisie	5,0

Cod produs

Descriere produs

Pret Euro (fara TVA)

**BT6000027 BTA-MF360 Multifunctional, motor Loncin G200F 6,5 CP**

784

Monocilindric, 4 timpi, răcit cu aer.

Alimentare cu benzină fără plumb. Capacitate rezervor combustibil 3,6 l, ulei motor 0,6 l.

Demaror manual. Cutie de viteze cu priză de putere.

2 viteze înainte + 2 viteze înapoi.

Dimensiune roți 6.00-8

Recomandat pentru suprafețe între 2.000 și 10.000mp

**Set livrare** - Multifuncțional fără accesorii.



**ACCESORII Multifuncțional BTA-MF360**

BT7000494 **Freză BTA-TI360**. Lățime de lucru 620 mm. Adâncime 200 mm (1)

353

BT7000495 **Sistem cosire BTA-GC360**. Lățime de lucru 970 mm. Înălțime tăiere 20-60 mm (2)

402

BT7000496 **Dispozitiv măturat BTA-SW360**. Lățime lucru 900mm. Ajustare înălțime 0-50 mm (3)

481

BT7000497 **Plug zăpadă BTA-DB360**. Lățime de lucru 850 mm. Ajustare înălțime 0-50 mm (4)

231

BT7000498 **Freză zăpadă BTA-ST360**. Lățime de lucru 560 mm. Distanța de aruncare 6m (5)

384

BT7000499 **Set roți metalice și plug BTA-SP360**. Distanță exterioară roți 420mm (6)

132

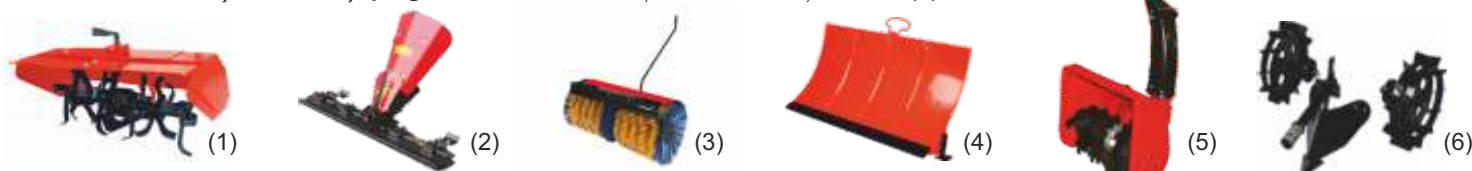

**BT6000028 BTA-MF400 Multifunctional, motor Dingking 15 CP**

1343

Monocilindric, 4 timpi, răcit cu aer.

Alimentare cu benzină fără plumb. Capacitate rezervor combustibil 6 l, ulei motor 1,1 l.

Demaror manual. Cutie de viteze cu priză de putere.

3 viteze înainte + 3 viteze înapoi.

Dimensiune roți 5.00-10

Recomandat pentru suprafețe între 2.000 și 20.000mp

**Set livrare** - Multifuncțional fără accesorii.



**ACCESORII Multifuncțional BTA-MF400**

BT7000500 **Freză BTA-TI400**. Lățime de lucru 800 mm. Adâncime 200 mm (1)

379

BT7000501 **Sistem cosire BTA-GC400**. Lățime de lucru 1.200mm.

465

Înălțime tăiere 20-60 mm (2)

BT7000502 **Dispozitiv măturat BTA-SW400**. Lățime de lucru 1.100 mm (3)

777

BT7000503 **Plug zăpadă BTA-DB400**. Lățime de lucru 920 mm (4)

302

BT7000504 **Freză zăpadă BTA-ST400**. Lățime de lucru 720 mm (5)

490

BT7000505 **Plug bilonat BTA-SP400** (6)

120

BT7000506 **Plug arat BTA-PL400** (7)

138

BT7000507 **Roți metalice BTA-MW500** (8)

98

BT7000508 **Greutăți roți** (9)

151

BT7000509 **Roți duble cauciuc** (10)

172





# Motocultoare / Masini multifunctionale / Accesorii Motorizare HONDA

Cod produs	Descriere produs	Pret Euro (fara TVA)
BTA-FLASH150H	<b>Motocultor BTA-FLASH150H</b> fara cover, motor HONDA GX200, 196 cmc, benzina, 6,5 CP, transmisie curea, roti 4.00-8 SET LIVRARE 2 x Roată de cauciuc 4.00-8 / 40 cm 1 x Set două freze segmentabile, 2+1 1 x Tijă reglare adâncime 2 x Manicot (tub rotund) Greutate neta 55 Kg	774 <b>HONDA</b>
BTA-FLASH250H	<b>Motocultor BTA-FLASH250H</b> cover, motor HONDA GX200 196 cmc, benzina, 6,5 CP, transmisie: cutie de viteze cu priză de putere, corp fonta, roti 4.00-8 SET LIVRARE 2 x Roată de cauciuc 4.00-8 / 40 cm 1 x Set două freze segmentabile, 2+1 1 x Suport fix pentru accesorii 1 x Tijă reglare adâncime 2 x Manicot (tub hexagonal) Φ26 mm, 4 găuri Greutate neta 85 Kg	941 <b>HONDA</b>
BTA-FLASH300H	<b>Motocultor BTA-FLASH300H</b> cover, motor HONDA GX200 196 cmc, benzina, 6,5 CP, transmisie: cutie de viteze cu priză de putere, corp fonta, roti 4.00-8 SET LIVRARE 2 x Roată de cauciuc 4.00-8 / 40 cm 1 x Set două freze segmentabile, 2+1 1 x Suport fix pentru accesorii 1 x Tijă reglare adâncime 2 x Manicot (tub hexagonal) Φ26 mm, 4 găuri Greutate neta 90 Kg	1015 <b>HONDA</b>
BTA-F1107X200	<b>BTA-F1107X200 Multifunctional, motor HONDA GX200 6,5 CP</b> Monocilindric, 4 timpi, răcit cu aer. Alimentare cu benzină fără plumb. Capacitate rezervor combustibil 3,6 l, ulei motor 0,6 l. Demaror manual. Cutie de viteze cu priză de putere. 2 viteze înainte + 2 viteze înapoi. Dimensiune roți 4.00-10 Recomandat pentru suprafețe între 2.000 și 20.000mp <b>Set livrare</b> - Multifuncțional fără accesorii.	1.692 <b>HONDA</b>
BTA-F1107X270	<b>BTA-F1107X270 Multifunctional, Idem. Motor HONDA GX200 9 CP</b> Capacitate rezervor combustibil 5,3 l, ulei motor 1,1 l. Roți 5.00-10	2.025
<b>Accesorii masini multifunctionale</b>		
BTA-RT60F	<b>Freză BTA-RT60F</b> , lățime de lucru 600 mm, adâncime 200 mm (a)	679
BTA-MG1107DRY	<b>Transmisie in ulei BTA-MG1107DRY</b> (b)	569
BTA-FM110F	<b>Lama cosire tip "Finger" BTA-FM110F</b> , lățime de lucru 1.100 mm (c)	403
BTA-DM110F	<b>Lama cosire tip "Dual Blade" BTA-DM110F</b> , lățime de lucru 1.100 mm (d)	440





# Motoburghie / Trenchere / Remorci motocultoare

Cod produs

Descriere produs

Pret Euro (fara TVA)

7403284155122 **Pachet BTA-25M-ACC1 Motoburghiu 2.5 CP** 154

+7403284155160 Motor monocilindric in 2 timpi, benzina, 58 cc, 0 - 350 rpm, demaror la sfoara, greutate neta 10 kg, dim. ambalaj 480x390x330 mm  
+BT7000005 SET LIVRARE: Motoburghiu BTA-25M, burghiu tip A 150 x 1.000 mm, burghiu tip B 200 x 1.000 mm



7403284155139 **Pachet BTA-30M-ACC2 Motoburghiu 3.0 CP** 208

+7403284155160 Motor monocilindric in 2 timpi, benzina, 68 cc, 0 - 350 rpm, demaror la sfoara, greutate neta 10 kg, dim. ambalaj 480x410x360 mm  
+ BT7000005  
+ 7403284197368 SET LIVRARE: **Burghiu 150, 200 si 250 mm**

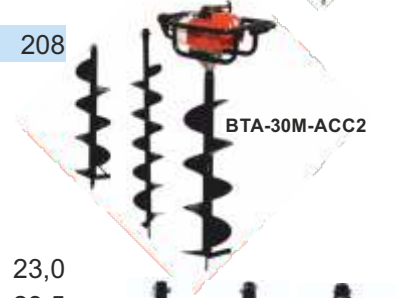

7403284155160 **Burghiu BTA-BA150**, diametru 150, adancime 1.000 mm, tip A 23,0

3533254142006 **Burghiu BTA-BA200**, diametru 200, adancime 1.000 mm, tip A 29,5

7403284197368 **Burghiu BTA-BA250**, diametru 250, adancime 1.000 mm, tip A 37,3

BT7000004 **Burghiu BTA-BB150**, diametru 150, adancime 1.000 mm, tip B 26,2

BT7000005 **Burghiu BTA-BB200**, diametru 200, adancime 1.000 mm, tip B 28,7

BT7000006 **Burghiu BTA-BB250**, diametru 250, adancime 1.000 mm, tip B 26

BT7000007 **Burghiu BTA-BD150**, diametru 150, adancime 1.000 mm, tip D 28

BT7000008 **Burghiu BTA-BD200**, diametru 200, adancime 1.000 mm, tip D 32

BT7000009 **Burghiu BTA-BD250**, diametru 250, adancime 1.000 mm, tip D 43,8

BT7000010 Arc antivibratie 14,4

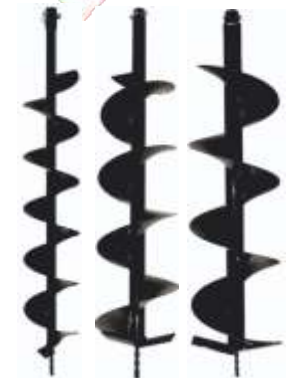

7403284155085 **BTA-450TR Masina sapat santuri (trencher) 6,5 CP**, adancime max. sapare 1705

450 mm. Ajustare adâncime săpare: 150, 250, 350, 450 mm. Sapare 60 m/ora. Lanț 21 dinți.

Motor monocilindric, 4 timpi, racire cu aer, benzina, demaror la sfoara.

Greutate 135 Kg, dim. ambalaj 1.060x765x850mm



BT6000014 **BTA-600TRE Masina sapat santuri (trencher) 15 CP**, adancime max. sapare 2073

600 mm. Ajustare adâncime săpare: 200, 400, 600 mm. Sapare 60 m/ora.

Lanț 27 dinți.

Motor monocilindric, 4 timpi, racire cu aer, benzina, demaror electric cu pornire la cheie - baterie inclusa.

Greutate 185 Kg, dim. ambalaj 1.140x765x850mm



BT6000036 **BTA-500R Remorca agricola, sarcina max.500 Kg** 378

Frana mecanica pe tambur, frana de picior si de mana, suspensie pe foi de arc.

Roti pneumatice 4.00-12

Greutate 120 kg, dim. cuva 1.250 x 800 x 500 mm.



BT6000020 **BTA-600R Remorca agricola, sarcina max.600 Kg** 496

Frana mecanica pe tambur, frana de picior si de mana, suspensie pe foi de arc,

picior de sprijin, sistem basculare. Roti pneumatice 4.00-12

Greutate 135 kg, dim. cuva 1.400 x 1.000 x 500 mm.



BT7000102 Roata cauciuc 4.00-12 36







BT7000103 Anvelopa 4.00-12 22,2

BT7000104 Camera 4.00-12 5,8





# Motopompe

Cod produs	Descriere produs	Pret Euro (fara TVA)	
<b>MOTOPOMPE APE CURATE</b>			
BT6000029	<b>BTA-MP25 Motopompa ape curate</b> Ø 25 mm - 1" Debit - 4 m³/h Motor 2,5 cp-98CC, Rezervor carburant 1,35L Adancime 6 m - inaltime pompare 9m Senzor lipsa ulei cu led rosu si oprire motor. Greutate: 11kg.	133	
BT6000030	<b>BTA-MP40 Motopompa ape curate</b> Ø 40 mm - 1,5" Debit - 12 m³/h Motor 2,5 cp-98CC, Rezervor carburant 1,35L Adancime 6 m - inaltime pompare 25m Senzor lipsa ulei cu led rosu si oprire motor. Greutate: 12kg.	135	
<b>MOTOPOMPE APE SEMICURATE</b>			
BT6000031	<b>BTA-MP50 Motopompa ape semicurate</b> Ø 50 mm - 2" Debit - 500 l/min. Motor 7 cp-208CC, Rezervor carburant 3,6L Adancime 7 m - inaltime pompare 25m Senzor lipsa ulei cu led rosu si oprire motor. Greutate: 25kg.	168	
BT6000032	<b>BTA-MP80 Motopompa ape semicurate</b> Ø 80 mm - 3" Debit - 830 l/min. Motor 7 cp-208CC, Rezervor carburant 3,6L Adancime 7 m - inaltime pompare 20m Senzor lipsa ulei cu led rosu si oprire motor. Greutate: 28kg.	186	
BT6000033	<b>BTA-MP100 Motopompa ape semicurate</b> Ø 100 mm - 4" Debit - 1.330 l/min. Motor 7.5 cp-223CC, Rezervor carburant 3,6L Adancime 7 m - inaltime pompare 28m Senzor lipsa ulei cu led rosu si oprire motor. Greutate: 37kg.	260	
<b>MOTOPOMPE DE PRESIUNE</b>			
BT6000034	<b>BTA-MPP50 Motopompa de presiune</b> Ø 50 mm - 2" Debit - 300 l/min. H max. 80m Motor 7 cp-208CC, Rezervor carburant 3,6L Adancime 7 m - inaltime pompare 80m Senzor lipsa ulei cu led rosu si oprire motor. Greutate: 26kg.	247	
BT6000035	<b>BTA-MPP80 Motopompa de presiune</b> Ø 80 mm - 3" Debit - 830 l/min. H max. 70m Motor 14 cp-420CC, Rezervor carburant 6,5L Adancime 7 m - inaltime pompare 70m Senzor lipsa ulei cu led rosu si oprire motor. Greutate: 47kg.	422	

# Accesorii motopompe

Cod produs

Descriere produs

Pret Euro (fara TVA)

## FURTUNURI

RO0008378 **Furtun absorbție** Ø 25 mm 1" - 7 bar  
 RO0008379 **Furtun absorbție** Ø 50 mm 2" - 5 bar  
 RO0008380 **Furtun absorbție** Ø 75 mm 3" - 4 bar  
 RO0008381 **Furtun absorbție** Ø 100 mm 4" - 4 bar

RO0009272 **Furtun refulare** Ø 25 mm 1" - 7 bar  
 RO0008383 **Furtun refulare** Ø 50 mm 2" - 5 bar  
 RO0008384 **Furtun refulare** Ø 75 mm 3" - 4 bar  
 RO0008385 **Furtun refulare** Ø 100 mm 4" - 4 bar

RO0009273 **Furtun textil tip pompier** L 20m Ø 50 mm 2" - 10 bar Include racorduri Storz  
 RO0009274 **Furtun textil tip pompier** L 20m Ø 75 mm 3" - 10 bar Include racorduri Storz  
 RO0009275 **Furtun textil tip pompier** L 20m Ø 100 mm 4" - 7 bar Include racorduri Storz

\*Prețurile afișate sunt pe ml. Comanda minimă este de 10 ml/multiplu de 10.



## COLIERE SI CUPLE STORZ

218022052055 Colier pentru cupla Storz, diam. max. 55mm  
 218024074079 Colier pentru cupla Storz, diam. max. 79mm  
 217003051000 Cupla Storz fixa 2"-50mm  
 217003076000 Cupla Storz fixa 3"-75mm  
 217002051000 Cupla Storz mobila 2"-50mm  
 217002076000 Cupla Storz mobila 3"-75mm

1,2  
 2,0  
 6,1  
 10,2  
 5,8  
 11,1







# Masini si tractoare de tuns iarba

Cod produs

Descriere produs

Pret Euro (fara TVA)

## MASINI DE TUNS IARBA

3161304182346 **BTA-MTG425 Masina tuns iarba autopropulsata, motor benzina 2.7CP** 201

Motor NP130 pe benzină 2.0 kW / 132 cc / 2.800 rpm

Lățime tăiere: 410 mm

Inălțime tăiere ajustabilă: 25-75 mm

Volum sac textil iarba: 45L

Dimensiuni ambalaj: 685x530x440 mm



3161304182353 **BTA-MTG450 Masina tuns iarba autopropulsata, motor benzina 3.1CP** 244

Motor NP150 pe benzină 2.3 kW / 149 cc / 2.800 rpm

Lățime tăiere: 460 mm

Inălțime tăiere ajustabilă: 25-75 mm

Volum sac textil iarba: 60L

Dimensiuni ambalaj: 815x580x530 mm



3161304182360 **BTA-MTG500 Masina tuns iarba autopropulsata, motor benzina 3.5CP** 269

Motor NP170 pe benzină 2.6 kW / 171 cc / 2.800 rpm

Lățime tăiere: 508 mm

Inălțime tăiere ajustabilă: 25-75 mm

Volum sac textil iarba: 60L

Dimensiuni ambalaj: 900x580x530 mm



## TRACTOARE DE TUNS IARBA

BT6000058 **BTA-TTG630 Tractor tuns iarba, motor Loncin benzina, 7CP** 1.171

**Nou!**

Transmisie hidrostatica. Pornire la cheie.

Lățime tăiere: 610 mm

Inălțime tăiere ajustabilă: 35-75 mm

Volum sac textil iarba: 150L

Greutate: 113 kg

Dimensiuni: 1.480 x 760 x 830 mm



BT6000059 **BTA-TTG840 Tractor tuns iarba, motor Loncin benzina, 11CP** 1.811

**Nou!**

Transmisie hidrostatica. Pornire la cheie.

Lățime tăiere: 840 mm

Inălțime tăiere ajustabilă: 35-75 mm

Volum sac textil iarba: 220L

Greutate: 163 kg

Dimensiuni: 1.690 x 1.000 x 860 mm



BT6000060 **BTA-TTG1070 Tractor tuns iarba, motor Loncin benzina, 14CP** 2.240

**Nou!**

Transmisie hidrostatica. Pornire la cheie.

Lățime tăiere: 1.070 mm

Inălțime tăiere ajustabilă: 35-75 mm

Volum sac textil iarba: 220L

Greutate: 189 kg

Dimensiuni: 1.700 x 1.130 x 860 mm





# Atomizoare Aparate de spalat cu presiune

Cod produs

Descriere produs

Pret Euro  
(fara TVA)

## ATOMIZOARE - PULVERIZARE UNIVERSALA

BT6000024 **Atomizor BTA-MB650Y 1,8CP** cu pompa booster inclusa, inaltime lucru 10m 148  
Turație maximă: 7.000 rpm  
Pulverizare universala.  
Greutate netă/brută: 9 kg/10 kg. Dimensiuni ambalaj: 510x380x650 mm

BT6000025 **Atomizor BTA-MD600Y 3,4CP** cu pompa booster inclusa, inaltime lucru 12m 204  
Turație maximă: 7.000 rpm. Capacitate rezervor: 14 l  
Pulverizare universala - pulverizare particule solide.  
Greutate netă/brută: 10,5 kg/12 kg. Dimensiuni ambalaj: 500x340x680 mm



## Aparate de spalat cu presiune

3533254132977 **BT1500-A Aparat de spalat cu presiune** 66,2  
Presiune max.: 120bar, motor electric: 230V, putere max.: 1.400W  
Debit: 300 l/ora  
Greutate: 6,5 kg, Dimensiuni LxIxh 260 x 250 x 460 mm









3533254132984 **BT1900-B Aparat de spalat cu presiune** 99,4  
Presiune max.: 135bar, motor electric: 230V, putere max.: 1.800W  
Debit: 360 l/ora  
Greutate: 9,1 kg, Dimensiuni LxIxh 350 x 320 x 705 mm

3533254132991 **BT2350-B Aparat de spalat cu presiune** 115  
Presiune max.:160bar, motor electric: 230V, putere max.: 2.200W  
Debit: 360 l/ora  
Greutate: 10,2 kg, Dimensiuni LxIxh 350 x 320 x 705 mm





## Despicatoare lemne / Tocatoare crengi

Cod produs	Descriere produs	Pret Euro (fara TVA)	
BT6000051	<b>BTA-DO6T Despicator lemne orizontal</b> , putere max. despicare 6 t Motor electric 2,2 kW 230V, Dimensiune bustean (L max./ Ø max.) 520 mm / 300 mm, Cursa cutit despicare 385 mm, Diametru cutit despicare 55 mm, Greutate: 67 kg, dim. ambalaj (LxIxH) 1.000x410x540 mm	396	
BT6000045	<b>BTA-DV8T Despicator lemne vertical</b> , putere max. despicare 8 t Motor electric 3,0 kW 230V, Dimensiune bustean (L max./ Ø max.) 650 mm / 400 mm, Cursa cutit despicare 192 mm Greutate: 102 kg, dim. ambalaj (LxIxH) 710x450x1.170 mm	685	
BT6000052	<b>BTA-DV10TMONO Idem</b> , putere max. despicare 10 t, 230V, greutate 108 kg	780	
BT6000053	<b>BTA-DV12TMONO Idem</b> , putere max. despicare 12 t, 230V, greutate 109 kg	809	
BT6000046	<b>BTA-DV10T Despicator lemne vertical</b> , putere max. despicare 10 t Motor electric 3,0 kW 400V, Dimensiune bustean (L max./ Ø max.) 650 mm / 500 mm, Cursa cutit despicare 192 mm Greutate: 110 kg, dim. ambalaj (LxIxH) 710x450x1.170 mm	906	
BT6000047	<b>BTA-DV12T Despicator lemne vertical</b> , putere max. despicare 12 t Motor electric 3,5 kW 400V, Dimensiune bustean (L max./ Ø max.) 650 mm / 500 mm, Cursa cutit despicare 192 mm Greutate: 110 kg, dim. ambalaj (LxIxH) 710x450x1.170 mm	929	
BT6000048	<b>BTA-DV15T Despicator lemne vertical</b> , putere max. despicare 15 t Motor electric 4,0 kW 400V, Dimensiune bustean (L max./ Ø max.) 1.100 mm / 500 mm, Cursa cutit despicare 192 mm Greutate: 183 kg, dim. ambalaj (LxIxH) 1.700x550x800 mm	1239	
BT6000049	<b>BTA-DV18T Despicator lemne vertical</b> , putere max. despicare 18 t Motor electric 4,0 kW 400V, Dimensiune bustean (L max./ Ø max.) 1.100 mm / 500 mm, Cursa cutit despicare 192 mm Greutate: 193 kg, dim. ambalaj (LxIxH) 1.700x550x800 mm	1336	
BT6000015	<b>BTA-100T Tocator crengi 6,5 CP</b> , diam. max. tocare 100 mm. Motor monocilindric, 4 timpi, racire cu aer, benzina, demaror la sfoara. Dim. roti 3.50 - 6 Greutate 85 Kg, dim. ambalaj 895x765x1.210mm	678	
BT6000016	<b>BTA-120TE Tocator crengi 15 CP</b> , diam. max. tocare 120 mm. Motor monocilindric, 4 timpi, racire cu aer, benzina, demaror electric cu pornire la cheie - baterie inclusa. Dim. roti 4.00 - 10 Greutate 100 Kg, dim. ambalaj 880x565x840mm	1328	

## SISTEME DE POMPARE

**WAGNER**



Pompe airless cu membrana pentru zugravit  
Pagina 61



Pompe airless cu membrana pentru vopsit  
Pagina 63



Pompe airless cu piston pentru zugravit  
Pagina 65



Pompe airless hidraulice pentru gleturi  
Pagina 68



Pompe airless cu membrana pentru hidroizolatii si injectari  
Pagina 69



Pompe pentru gleturi | tencuieli | decorative  
Pagina 70

## ECHIPAMENTE PENTRU FINISARE

**Columbia**  
TAPING TOOLS



Echipamente pentru finisare gips carton  
Pagina 72

**ROKAMAT**  
Produce fabricate in Germania



Echipamente pentru slefuit, raschetat, polisat  
Pagina 73



4004025129872 **SuperFinish 21 PRO HEA, SprayPack, motor 230V, 0,9 kW** 1.081



Debit material 2,1 l/min., presiune 250 bar; duza max. 0.021"

**Echipare standard:** furtun material DN6, max. 207 bar, pistol airless Vector Pro, garda protectie, duza HEA ProTip 517, manometru.



WA2366619 **SuperFinish 23 Select Basic Cart, motor 230V, 1,3 kW - doar pompa** 1.521

Debit material 2,6 l/min., presiune 250 bar

**Nu include** sistem aspiratie manometru, furtun

**Se configureaza la cerere vezi mai jos.**

**Kit zugraveli pentru SF23 Select Basic contine:** 547

4004025085710 Sistem absorbtie dedicat pt SF23Select 166,2

WA9984574 Furtun material 1/4" DN6, 15m 142

4004025084928 Pistol VectorPro cu garda inclusa 207

24964217656 Duza 517 26,1

**Kit zugraveli/vopsitorii pentru SF23 Select Basic contine:** 394

4004025015069 Recipient pentru material cu capac 5L 72,3

WA9984583 Furtun material 1/4" DN6, 7,5m 79,6

4004025084928 Pistol VectorPro cu garda inclusa 207

024964219155 Duza 410 34,2



WA2399198 **SuperFinish 23 PRO HEA, SprayPack, motor 230V, 1,3 kW** 2.002

Debit material 2,6 l/min., presiune 250 bar; duza max. 0.023"

**Echipare standard:** furtun material 15m, DN6, max. 250 bar, pistol airless Vector Pro 1/4" tragaci cu 4 degete, garda protectie, duza HEA ProTip 519, manometru, cutie pentru scule



4004025081330 **SuperFinish 23 Plus HEA SprayPack, motor 230V, 1,3 kW** 2.657

Debit material 2,6 l/min., presiune 250 bar; duza max. 0.023"

**Echipare standard:** sistem aspiratie, PumpRunner inclus, furtun material DN6, max. 270 bar, 15m, manometru HEA, pistol airless 1/4", duza HEA 519



WA2388260 **SuperFinish 33 PRO Spraypack, motor 230V, 2,2 kW** 4.274

Debit material 4,2 l/min., presiune 250 bar, duza max. 0.033"

**Echipare standard:** unitate de baza; sistem aspiratie flexibil, furtun material DN6, 1/4", 15m; pistol airless Vector Pro; duza TradeTip 3 523; filtru pistol alb



WA2388259 **SuperFinish 33 PLUS Spraypack Cart, motor 230V, 2,2 kW** 4.847

Debit material 4,2 l/min., presiune 250 bar, duza max. 0.033"

Sistem de functionare in pozitie verticala si orizontala, priza 230V

**Echipare standard:** sistem aspiratie metalic, furtun material DN6 max. 270 bar, 15m, pistol airless 1/4", duza.



**Transforma-ti echipamentul SuperFinish 23 PLUS din aplicatii pentru zugravit in aplicatii pentru vopsit (nu include compresorul).**

**Kit-ul Air Coat** contine:

4004025015069	Recipient pentru material 5l	72,3
4004025062933	Furtun dublu pentru material DN3 1/4" si aer DN6, 7,5 m	160
WA2368269	Pistol AirCoat include duza airless BlueAir si cap protectie	489
WA379411	Duza ACF3000 11/40	126
WA340250	Regulator AirCoat	132



Optional:

WA2347935	<b>Compresor AirBoost 100</b> , debit aer 100 l/min., motor 230V - 480W	1.069
-----------	---	-------

*in cazul utilizarii acestui compresor nu mai adauga regulatorul de mai sus*

WA2406208	<b>Kit-uri zugraveli DN6 pentru PS 3.39, HC 750, HC 950, HC 970 incl.SSP</b>	735
-----------	--	-----

Adaptor montare (F) NPSM 1/2 "la (M) NPMS 1/4"  
 2 x furtunuri de inalta presiune DN 6; NPSM 1/4 ", 15m (max. 27 Bar)  
 Conector dublu 1/4 "NPSM; Pistol airless Vector Pro; Extensie duza filet G 15cm si G 30cm  
 Duza - HEA ProTip 519 + duza - TradeTip 3 427; Recipient curatare duze TipClean 200 ml  
 2 chei reglabile; 10 buc. filtre albe



WA2406209	<b>Kit finisaj, materiale de umplere DN10 pentru PS 3.39, HC 750, HC 950, HC 970 incl. SSP</b>	674
-----------	--	-----

Adaptor montare (F) NPSM 1/2 " la (M) NPMS 3/8"  
 Furtun de inalta presiune DN 6; NPSM 3/8 ", 15m (max. 25 Bar)  
 Conector dublu de la 3/8" NPSM la 1/4" NPSM; Pistol AG 14 (filet G); Extensie duza filet G 30cm  
 Duza - TradeTip 3 335; Duza - TradeTip 3 439; Recipient curatare duze TipClean 200 ml  
 2 chei reglabile; 10 buc. filtre albe



4004025099069	<b>Kit-uri vopsitorie, lacuire DN4 pentru modelele SF 23, SF 33, SF 27, SF 31</b>	490
---------------	---	-----

Furtun de inalta presiune DN 4; NPSM 1/4 ", 7,5m (max. 27 Bar)  
 Pistol airless Vector Pro; Extensie duza filet G 15cm  
 Duza FineFinish - TradeTip 3 308 (lac); Duza FineFinish- TradeTip 3 412 (materiale de umplere)  
 Recipient curatare duze TipClean 200 ml; Filtre rosii (10 bucati)  
 Rezervor material 5l; M36 x 2



WA2406206	<b>Kit-uri lacuire DN4 pentru modelele PS 20, PS 3.20, PS 3.21, PS 3.25</b>	674
-----------	---	-----

Furtun de inalta presiune DN4; NPSM; 1/4", 7,5m (max. 27 bar)  
 Pistol airless Vector Pro; Extensie duza filet G 15cm  
 Duza FineFinish TradeTip 3 308 (lac); Duza FineFinish TradeTip 3 412 (materiale de umplere)  
 Recipient curatare duze TipClean 200ml; Filtre rosii (10 bucati)  
 Rezervor material 5l; ProSpray; Filtre rezervor pentru lac



WA2408212	<b>Kit HEA DN6 pentru SuperFinish, ProSpray; PowerPainter si Impact</b>	490
-----------	---	-----

Furtun de inalta presiune DN6; NPSM; 1/4", 15m (max. 27 bar)  
 Pistol airless Vector Pro; Extensie duza filet G, 15 cm  
 Duza - HEA ProTip 517; Duza - HEA ProTip 311  
 Recipient curatare duze TipClean 200 ml; Filtre albe (10 bucati)



Cod produs	Descriere produs	Pret Euro (fara TVA)	
4004025129889	<b>SuperFinish 21 LACQ</b> , motor 230V, 0,9 kW Debit material 2,1 l/min., presiune max. 207 bar; Duza max. 0.021" <b>Echipare standard:</b> unitate de baza, recipient material 5 l, furtun material DN3, manometru; Pistol Vector Pro; Duza TradeTip 3 FineFinish 410	1.274	
WA311061	<b>Finish 230 Enamel Spraypack skid</b> , motor 230V, 1,1 kW Debit material 1,25 l/min., presiune max. 260 bar; Duza max. 0.019" <b>Echipare standard:</b> furtun material DN4, 270 bar, 4", 7,5 m; Pistol Airless Pro 1/4"; Duza reversibila dubla L10, 208/510; Filtru pistol rosu 180MA, recipient material 5 l	1.420	
			<b>LICHIDARE STOC</b>
WA2341492	<b>SuperFinish 23 Plus Enamel Spraypack cart</b> , motor 230V, 1,3 kW Debit material 2,6 l/min., presiune 250 bar; Duza max. 0.023" <b>Echipare standard:</b> furtun material DN 3, max. 270 bar, 7,5 m; pistol airless 1/4"; Duza dubla reversibila L10, 208/510; Filtru pistol 180 MA	2.639	
WA2341496	<b>SuperFinish 23 Plus TempSpray Spraypack cart</b> , motor 230V, 1,3 kW Debit material 2,6 l/min., presiune 250 bar; Duza max. 0.023" <b>Echipare standard:</b> Unitate de baza; recipient material 5 l; TempSpray H126; pistol airless Vector grip; Duza dubla L10, 208/510; Filtru pistol rosu extra fin	4.240	
WA2353393	<b>SuperFinish 23 Plus AirCoat Enamel Spraypack</b> , motor 230V, 1,3 kW Debit material 2,6 l/min., presiune max. 250 bar; Duza max. 0.023" <b>Echipare standard:</b> unitate de baza; furtun dublu 1/4", 10m; material DN4, aer DN6; Pistol AirCoat AC 4600 Professional; duza airless ACF3000 11/40 verde; Compresor AirBoost 100; regulator AirCoat, kit fittinguri.	4.235	
<b>Temp Spray furtun incalzit (20-60°C) pentru material, asigura o mai buna vascozitate</b>			
4004025065712	TempSpray H126 BasicUnit 0,6kW si 10m furtun (nu include pistolul)	1.907	
WA2311660	TempSpray H226 BasicUnit 1,1kW si 15m furtun, tambur inclus (nu include pistolul)	2.735 1274	

Cod produs

Descriere produs

Pret Euro (fara TVA)

**Transforma-ti echipamentul SuperFinish 23 PLUS din aplicatii pentru vopsit in aplicatii pentru zugravit.**

**Kit-ul Spray Pack include:**

		<b>658</b>
WA2342879	Sistem aspirare, PumpRunner inclus	195
WA9984574	Furtun 15m, 1/4", 270 bar	142
024964240555	Pistol airless Vector Grip, 1/4", include garda protectie duza	269
WA271045	Duza dubla D10, 111/419	45,7



**Kit-ul HEA include:**

		<b>740</b>
WA2342879	Sistem aspirare, PumpRunner inclus	195
WA9984574	Furtun 15m, 1/4", 270 bar	142
WA2383995	Manometru presiune HEA	72,3
024964240555	Pistol Airless Vector Grip, 1/4", include garda protectie duza T	269
024964271009	Duza HEA 519	43,4



**Furtunuri duble AirCoat**

WA9984596	HP furtun dublu material DN3, max. 270 bar, aer DN6, 1/4", 10m	160
4004025062933	HP furtun dublu material DN3, max. 270 bar, aer DN6, 1/4", 7,5 m	164
WA2306802	HP furtun dublu material DN3, max. 270 bar, aer DN6, M16x1,5, 7,5 m	140
4004025063350	HP furtun dublu material DN4, max. 270 bar, aer DN6, 1/4", 10 m	178
WA2302378	HP furtun dublu material DN4, max. 270 bar, aer DN6, 1/4", 7,5 m	140
WA2306803	HP furtun dublu material DN4, max. 270 bar, aer DN6, M16x1,5, 7,5 m	140



**Pistoale AirCoat AC4500 si AC4600 Profesional, speciale pentru vopsitorie fina, intrare separata material si aer (nu include duza)**

4004025114571	AC4600 Profesional, cap BlueAir (vopsea baza apa) si garda protectie	606
WA394157	AC4600 Profesional, cap RedAir (vopsea baza solvent si apa) si garda	607
WA394158	AC4600 Profesional, cap GreenAir (vopsea baza solvent) si garda protectie	607
WA2368269	AC4500 Profesional, cap BlueAir (vopsea baza apa) si garda protectie	489
WA2368270	AC4500 Profesional, cap RedAir (vopsea baza solvent si apa) si garda	427
WA2368271	AC4500 Profesional, cap GreenAir (vopsea baza solvent) si garda protectie	501
WA379XXX	<b>Duze AirCoat ACF3000</b>	126





Cod produs

Descriere produs

Pret Euro (fără T.V.A.)

4004025130397 **Finish Control 4000, Pulverizator electric XVLP**

653



Putere motor 0,37 kW, 0,2 bar  
Volum recipient material 1.000 ml.  
Greutate cu si fara bateria 1,9 / 1,3 kg



4004025129964 **FineCoat 9700 L, Pulverizator electric XVLP/HVLP**

669



Putere motor 1.15 kW, 0,3 bar  
Volum recipient material 1.000 ml. Furtun aer 7,6 m. Cablu electric 4 m.  
Greutate 6,8 kg



4004025086670 **ControlMax® 1900 PRO Skid Pompa airless cu piston, debit material**

652



1,5l/min., duza max. 0.019", motor electric 0,6 kW

**TITAN**



4004025086717 **ControlMax® 1900 PRO Cart Pompa airless cu piston, debit material**

762



1,5l/min., duza max. 0.019", motor electric 0,6 kW

**TITAN**



- Suport durabil din otel cu maner telescopic
- Sureflo™ Valva amorsare – Usor si rapid de fiecare data
- Buton ON/OFF Control presiune
- Pistol cu maner confortabil si tragaci cu apasare usoara
- Filtru vopsea – previne infundarea pompei

Echipe standard **ControlMax® 1900 PRO Skid/Cart:**

Pistol airless HEA  
Duza HEA 517  
15 m furtun airless



4004025098673 **PowerPainter 90 Extra HEA Spraypack skid, motor 230V, 0,8 kW**

1.062

Debit material 1,3 l/min., presiune 207 bar; Duza max. 0.019"

**Echipe standard:** furtun material DN6, max. 270 bar, aer 1/4"- 15m  
Pistol Vector Pro 1/4", duza HEA 517, manometru



WA2414079 **PowerPainter 90 Extra Cart Idem**

989

Cod produs	Descriere produs	Pret Euro (fără T.V.A.)
------------	------------------	-------------------------

4004025126116	<b>ProSpray 3.20 HEA Spraypack skid</b> , motor 230V, 1kW	1.658
---------------	---	-------

Debit material 1,6 l/min., presiune 207 bar; Duza max. 0.021"  
**Echipare standard:** furtun material DN6, max. 270 bar, aer 1/4"- 15m  
 Pistol Vector Pro 1/4", duza HEA 517, manometru



WA532089	<b>ProSpray 3.21 HEA Spraypack skid</b> , motor 230V, 1,03kW	2.714
----------	--	-------

Debit material 2 l/min., presiune 221 bar; Duza max. 0.023", modul inteligent pentru comanda si control  
**Echipare standard:** furtun material DN6, max. 270 bar, aer 1/4"- 15m  
 Pistol Vector Pro 1/4", duza HEA 517, manometru, rezervor lubrifiere



WA2308260	<b>ProSpray 3.25 Spraypack cart</b> , motor 230V, 1,1kW	3.608
-----------	---	-------

Debit material 2,6 l/min., presiune 221 bar; Duza max. 0.027";  
**Echipare standard:** furtun material DN6, max. 270 bar, aer 1/4"- 15m  
 Pistol Vector Grip 1/4", duza dubla 111/419, rezervor lubrifiere



WA2308262	<b>ProSpray 3.31 SprayPack cart</b> , motor 230V, 1,84 kW	5.439
-----------	---	-------

Debit material 3,8 l/min., presiune 221 bar; Duza max. 0.032";  
**Echipare standard:** unitate de baza; furtun DN6, 1/4", 15m; pistol airless Vector Grip; garda protectie duza; Duza dubla D20, 115/421

2351261	<b>ProSpray 3.39 SprayPack cart</b> , motor 230V, 2,19 kW	6.516
---------	---	-------

Debit material 5,0 l/min., presiune 221 bar; Duza max. 0.039";  
**Echipare standard:** unitate de baza; furtun DN6, 1/4", 15m; pistol airless Vector Grip; garda protectie duza; Duza HEA 519; Conector dublu A = 1/4" NPS x 3/8" NPT; Conector dublu A = 3/8" NPT x A = 1/2" NPS

### SprayRoller pentru conectare cu pompa airless

WA2411697	<b>SprayRoller cadru 25 cm</b> , include SpeedShield	267
-----------	--	-----

Include: Sprayroller 25cm; duza TT3 415; SpeedShield; conector pivotant



4004025084676	<b>SprayRoller carcasa 23 cm</b> cu SpeedShield	489
---------------	---	-----

Include: Sprayroller 25cm; duza TT3 415; SpeedShield; conector pivotant



WA2418370	<b>Roller cu alimentare din interior</b>	60,0
-----------	--	------

Include: Roller cu alimentare din interior si rola

### Accesorii si piese de schimb

WA0998230	Rola 12 mm grosime	5,2
-----------	--------------------	-----

WA0245717	Rola 20 mm grosime	6,0
-----------	--------------------	-----

WA2325720	Manseta roller pentru distribuirea uniforma a materialului	6,0
-----------	--	-----

WA509907	Adaptor 90°	80
----------	-------------	----

WA2420538	Extensie ranforsata pentru rola 0,9 m	106
-----------	---------------------------------------	-----



Cod produs	Descriere produs	Pret Euro (fara TVA)	
<b>Pachet duza + filtru</b>			
WA553XXX	Duza 315 / 415 / 515 TradeTip 3, cu filtru galben pentru pistol inclus	26,1	
WA553XXX	Duza 417 / 419 / 421 / 423 TradeTip 3, cu filtru alb pentru pistol inclus	26,1	
WA553XXX	Duza 517 / 519 / 521 / 523 / 525 TradeTip 3, cu filtru alb pentru pistol inclus	26,1	
WA553643	Duza 643 TradeTip 3, cu filtru verde pentru pistol inclus	26,1	
WA554XXX	Duza 415 / 417 / 517 / 519 / 521 <b>HEA</b> ProTip	43,4	
WA554XXX	Duza 410 / 510 / 412 / 512 pentru solventi / vopsea	43,4	
WA271XXX	Duza dubla 111 / 419	45,7	
<b><span style="color:red">Nou!</span> Extensii si conectori</b>			
WA2418853	Extensie pistol airless 12,5 cm	35,7	
WA0556075	Extensie pistol airless 30 cm	40,1	
024964301027	Extensie pistol airless 50 cm	49,1	
WA2418856	Extensie pistol airless 75 cm	58,0	
WA2418862	Extensie pistol airless 90 cm	115	
4004025013430	Extensie pistol airless 100 cm	192	
WA2418863	Extensie pistol airless 180 cm	178	
WA2454974	Cot reglabil 360 (int/ext 1/4")	99,9	
WA2454968	Conector reglabil 360 (int/ext 1/4")	27,9	
WA2454969	Conector reglabil 360 (int/ext 3/8")	27,9	
<b>Pistoale airless</b>			
4004025084928	Pistol airless Vector Pro, 250 bar, 1/4" include garda protectie TradeTip3, tragaci full pentru 4 degete	207	<p>Vector Pro</p>
4004025084935	Pistol airless Vector Pro, 250 bar, 1/4" include garda protectie TradeTip3, tragaci ergonomic pentru 2 degete	207	<p>Vector Grip</p>
024964240555	Pistol airless Vector Grip, 250 bar, 1/4" include garda protectie TradeTip3, tragaci cu 2 sau 4 degete	269	
WA538085	Pistol Vector Infinity, 345 bar, filet G 1/4", include garda protectie TradeTip3, tragaci ergonomic cu 2 degete	421	<p>Vector Infinity</p>
024964206612	Pistol AG14, 270 bar, filet G 1/4", include garda protectie TradeTip3	273	<p>AG14</p>
WA502166	Pistol AG14, 270 bar, filet F 1/4", include garda protectie TradeTip3	280	
4004025077050	Pistol AG19, 250 bar, filet G 3/8", include garda protectie TradeTip3	355	<p>AG19</p>
WA2343778	Pistol AG19 530 bar, 1/4", include garda protectie TradeTip3	403	
<b>Furtunuri material</b>			
WA9984583	Furtun material DN3, 270 bar, NPS 1/4", 7,5 m	79,6	
WA2302374	Furtun material DN4, 270 bar, NPS 1/4", 10 m	107	
WA9984573	Furtun material DN4, 270 bar, NPS 1/4", 7,5 m	88,6	
WA9984574	Furtun material DN6, 270 bar, NPSM 1/4", 15 m	142	
WA9984575	Furtun material DN6, 270 bar, NPSM 1/4", 30 m	268	
WA2336583	Furtun material DN10, max. 250 bar, NPSM 3/8", 15 m	196	
WA2336584	Furtun material DN10, max. 250 bar, NPSM 3/8", 30 m	312	
WA2336585	Furtun material DN13, max. 250 bar, 3/8", NPSM 1/2", 15 m	339	
WA2336586	Furtun material DN19, max. 250 bar, NPSM 3/4", 15 m	655	

Cod produs	Descriere produs	Pret Euro (fara TVA)
	<b>Pompa electrica cu actionarea pistonului de catre grup hidraulic</b>	
WA2371027	<b>HeavyCoat 750E Spraypack</b> , motor 230V, 3,1 kW Debit material 6 l/min., presiune 250 bar Duza max. 0.043" <b>Echipare standard:</b> unitate de baza; furtun material DN13, 3/8", NPSM 1/2", 15m; furtun pentru manevrare DN10, 3/8", 2,5m, conector 3/8" x 1/2"; Pistol airless AG14, filet 1/4", garda protectie duza; Duza dubla S10, 235/527; conector 1/4" NPSM x A=3/8" NPSM	7.331
024964249510	<b>HeavyCoat 750E SSP Spraypack idem HC 750E</b> Echipare standard idem HC 750E fara conectorul 1/4xA=3/8"	7.661
WA2371029	<b>HeavyCoat 750G Spraypack motor Honda benzina</b> Debit material 7.6 l/min. presiune 250 bar, duza max. 0.041" Echipare standard idem HC750 E	7.921
WA2332184	<b>HeavyCoat 950 E Spraypack 230V, 3.1 kW</b> Debit material 6 l/min., presiune 250 bar; Duza max. 0.052" <b>Echipare standard:</b> Furtun material DN13, max. 250bar 1/2", 15m furtun pentru manevrare DN10, max. 250 bar 3/8", 2,5m, conector 3/8" - 1/2" Pistol airless AG19, filet 1/4", 250 bar garda protectie duza Duza dubla reversibila S10, 235/527	7.600
0249642135804	<b>HeavyCoat 950 E SSP Spraypack 230V, 3.1 kW</b> Idem 950 E, echipat cu valva tip lopata pentru o performanta imbunatatita Echipare standard: unitate de baza; furtun DN13, 3/8", NPSM 1/2", 15m; furtun pentru manevrare DN10, NPSM 3/8", 2.5m; conector 3/8" x 1/2"; pistol airless AG19 filet 3/8"; garda protectie duza; duza dubla S20, 243/539	8.139
WA2332186	<b>HeavyCoat 950 G Spraypack</b> , motor Honda benzina Debit material 8 l/min.; presiune 250 bar; duza max. 0.052" Idem echipare HC 950 E	8.842
WA2332191	<b>HeavyCoat 970 E Spraypack motor 400V, 5.5 kW</b> Debit material 10.3 l/min. presiune 250 bar; duza max. 0.056" Echipare standard: unitate de baza; furtun material DN13, NPSM 3/8", 15m; furtun pentru manevrare DN10, NPSM 3/8", 2,5m; conector 3/8" x 1/2"; conector I=1/4"NPSM X A=3/8" NPSM; Pistol AG14 1/4"; garda protectie duza; duza dubla S20, 243/539	8.400
WA2332193	<b>HeavyCoat 970 E SSP idem HC 970 E</b> Echipare standard: unitate de baza; furtun material DN13, NPSM 3/8", 15m; furtun pentru manevrare DN10, NPSM 3/8", 2,5m; conector 3/8" x 1/2"; ; Pistol AG19 1/4"; garda protectie duza; duza dubla S20, 243/539	9.438
WA2332192	<b>HeavyCoat 970 G motor Honda benzina</b> Debit material 12 l/min. presiune 250 bar, duza max. 0.056" Echipare standard: idem HC 970 E	9.438
	<b>SSP - Putere aditionala pentru materiale cu vascozitate mare</b>	
	Accesorii pentru seria <b>HeavyCoat</b>	
WA2309956	Container 100L cu roti si capac	944
WA2383128	Conector container - HeavyCoat	276
	<b>Ambele accesorii sunt compatibile cu toate pompele hidraulice Wagner si Titan, precum si Titan Performance1650.</b>	



Additional power "Special-Spray-Power" for high viscosity materials



WA2361599 **SuperFinish 23i Cart**, motor 230V, 1,3 kW 1.350

Debit material 2,6 l/min., presiune 250 bar

**Lichidare stoc**

**Echipare standard:** Rezervor material 5 l, manometru

**Accesorii de adaugat la versiunea de baza**

4004025084928 Pistol airless Vector Pro 1/4", tragaci cu 4 degete duza 3 Tip 3 207

9984574 Furtun material DN6, max. 270 bar 15m, 1/4" 142

WA97057 Furtun pentru manevrare cu duza conectare injectoare 130

43052 Garnitura pentru instalarea duzei 1,1



4004025126475 **SuperFinish 23 CR**, motor 230V, 1,3 kW 2.056,7

**Nou!**

Debit material 2,6 l/min., presiune 250 bar;

**Echipare standard:** Unitate de baza fara alte accesorii

**Accesorii de adaugat la versiunea de baza**

4004025091599 Rezervor material 5L 117

WA2405950 Sistem de aspiratie material rigid (11) 132

WA2392123 Sistem de aspiratie flexibil (12) la cerere

WA2353487 Manometru presiune pentru injectari 400 bar (8) 216

024964206612 Pistol airless AG14 (otel inoxidabil) 273

WA9984574 Furtun material DN6 270 bar, 1/4" NPSM, 15m lungime 142

WA2353789 Furtun pentru manevrarea cu vana si cuplaj mama (5) 484

4004025091520 Furtun pentru manevrarea cu vana si cuplaj tata (6) 391

WA554XXX Duza HEA Pro 43,4

WA553XXX Duza TradeTip3 26,1

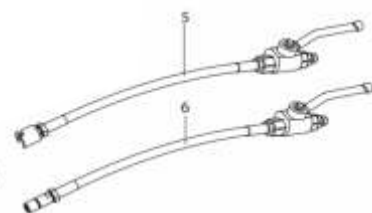
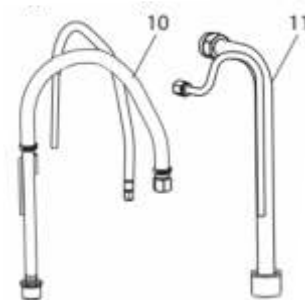

4004025086830 **PlastCoat 1030E Spraypack**, motor 230V, 2,2 kW 5.670

Debit material 15/ 20/ 25 l/min., presiune de operare 40 bar  
Distanța max. pompare 50m, Înălțime max. 30 m  
Granulometrie max. 6 mm

**Echipare standard:** furtun material DN25, M/V35, 10m, include furtun aer și cablu comanda, lance automată, include duza de 6 mm, trusa accesorii și accesorii curățare



WA2388301 **Pompa pentru materiale pastoase fluide** 6.480

**PlastCoat HP30 Spraypack**, motor 230V, 2,2 kW **NEW**

Debit material 10 kg/min., presiune de operare 120 bar  
Distanța max. pompare 20m, Înălțime max. 15 m

**Echipare standard:** furtun material diam. Ø 19mm, lungime 10 m, furtun pentru manevrare Ø 13 mm, lungime 2,5 m pistol pulverizare, duza 443, garda protecție duza, rezervor material 50 l



WA2400684 Echipare opțională kit zugrăveli pentru Plast Coat HP30, include: furtun 489

material DN10, max. 270 bar, aer 3/8" - 15m

Pistol Vector Pro 1/4", duza HEA 517, adaptori 3/4-3/8"



WA258720 Echipare opțională kit decorative pentru Plast Coat HP30, include: furtun 478

material DN19, max. 270 bar, aer 1/4" - 15m, conector

Pistol AG19, 4buc. duza 4/6/8/10mm, perie pentru curățare

WA2405153 Adaptor pistol-cap/duza decorativă 27,7



WA2359240 **Malaxor continuu PlastMIX 15** 2.587



Motor 230V - 1,4 kW debit material 15 l/min., capacitate cuva 60 l, granulometrie max. 5 mm, cadru reglabil pe înălțime.

Include pompa de apă



WA2351453 **SteamForce PRO- echipament profesional pentru îndepărtarea tapetului** 508

Putere motor 2,75 kW / 230V - 50 Hz

Placă eliberare abur 253x305 mm și 140x70 mm

Capacitate rezervor apă 7,5 l; autonomie 90 min.

Timp necesar pentru încălzire echipament 18 min.

Furtun flexibil 5 m lungime

Greutate echipament: 9,4 kg



Cod produs	Descriere produs	Pret Euro (fara TVA)	
<b>Compressoare electrice</b>			
4004025075537	<b>Compresor C330/03</b> compatibil cu PlastCoat 830 si 1030 Debit aer 330 l/min, presiune de lucru 10 bar, capacitate rezervor aer 3 l	808	
<b>Lanci aplicare material</b>			
4004025074660	Lance in-wall aplicare automata include conexiunea electrica	447	
WA2334122	Lance in-wall aplicare pneumatica	428	
WA2334155	Cap drept pentru lance automata	72,3	
4004025076305	Cap in unghi 70° pentru lancea pneumatica in-wall	244	
<b>Accesorii pentru lanci</b>			
WA2335388	Accesoriu pentru dozare (compatibil cu lancile 2334155 si 2337672)	72,3	
4004025076626	Accesoriu pentru adeziv (compatibil cu lancea 2334155 si 2337672)	60	
	Deflector - duza din poliuretan pentru tencuieli si gleturi 10, 12, 14, 16, 18 mm (compatibil cu lancile 2334121 si 2337672)	la cerere	
	Deflector - duza din otel inoxidabil pentru decorativa dim. 4, 5, 6, 7, 8, 9, 10, 12, 15 mm (compatibil cu lancile 2334155 si 2337672)	la cerere	
4004025010477	Deflector - kit duze otel inoxidabil 4 / 6 / 8 / 10 mm (compatibile cu lancile 2334155 si 2337672)	134	
WA2334123	Extensie lance 800 mm (compatibil cu cap lance 2334155)	293	
WA2339400	Extensie lance 1.500 mm (compatibil cu cap lance 2334155)	330	
WA296442	Extensie lance 2.000 mm (compatibil cu cap lance 2334155)	746	
WA342321	Conector furtun V(tata)35 / M(mama)25	58,7	
WA348920	Conector furtun V(tata)35 / M(mama)35	66,3	
WA342215	Suport pentru sustinerea furtunului (ex. prindere pe schela)	32,2	
WA2389048	Suport cu rola golire saci glet pentru HP30	881	
<b>Rotoare si statoare</b>			
WA2395996	Set rotor si stator pentru <b>HP30</b>	620	
WA348311	Stator W10/2.5, 270x89, negru pentru <b>PC 1030</b> , PC25, PC35	112	
WA348315	Stator W10/3, 270x89, galben pentru <b>PC 1030</b> , PC25, PC35	114	
WA348925	Stator W15/2, 270x89, maro pentru <b>PC 1030</b> , PC25, PC35	116	
WA2304954	Stator pentru <b>PC830</b> , PC430	76,1	
WA348312	Rotor W10/2.5 Ø40mm, L 317 mm, negru pentru <b>PC1030</b> , PC25, PC35	133	
WA348316	Rotor W10/3 Ø40mm, L 320 mm, galben pentru <b>PC1030</b> , PC25, PC35	137	
WA348926	Rotor W15/2 Ø40mm, L 320 mm, maro pentru <b>PC1030</b> , PC25, PC35	134	
WA2304986	Rotor pentru <b>PC830</b>	91,9	

Cod produs

Descriere produs

Pret Euro (fara TVA)

**C-DRYTOOLS C-DRYTOOLS** Echipament cu set complet pentru chituire profesionala 1.295

(imbinare gips carton)

Utilizare pentru paste de imbinare lichide sau preamestecate ce se aplica pe imbinari de gips carton si / sau la aplicarea de coltare perforate, banda de imbinare si banda de aluminiu.

Include urmatoarele 10 elemente:

1. Aplicator pentru pasta imbinare (ipsos) la unghi exterior 90°
2. Aplicator pentru pasta imbinare (ipsos) la unghi interior 90°
3. Aplicator pentru pasta imbinare (ipsos) pentru imbinare plata
4. Role pentru finisare coltar exterior 90°
5. Role pentru finisare coltar interior 90°
6. Aplicator pentru pasta finisare la unghi interior 90°(prima mana)
7. Aplicator pentru pasta finisare la unghi interior 90°(a doua mana)
8. Pompa-Applicator pentru incarcare (se conecteaza la pozitiile 1,2,3)
9. Prelungitor (se conecteaza la pozitiile 4,5,6,7)
10. Conector pentru maner



**C-BAZOOKA C-BAZOOKA** Echipament pentru imbinari plane si colturi interioare gips 2.467

carton, compus din rezervor pasta, suport rola imbinare, sistem de taiere a benzii de imbinare, cap aplicator pentru banda si pasta de imbinare, aplicare si presare banda in unghiuri interne.

**Utilizare:** pentru paste de imbinare lichide sau preamestecate ce se aplica pe imbinari de gips carton si / sau la aplicarea de coltare perforate, banda de imbinare si banda cu aluminiu.



**C-PUMP C-Pump** Pompa pentru umplere cu pasta  
Se utilizeaza cu art. C-Bazooka, C-BOX20, C-BOX25, C-BOX30

460

**C-GOOSENECK C-Gooseneck** Conector pompa Bazooka  
Se utilizeaza pentru conexiunea pompei C-PUMP cu C-BAZOOKA

145

**C-APB C-APB** Conector pompa - BOX  
Se utilizeaza pentru conexiunea pompei C-PUMP cu accesoriile C-BOX

88,3

**C-MBOX C-MBOX** Maner 1.800 mm lungime, 1,36 kg, pentru aplicatoare BOX  
Se utilizeaza impreuna cu C-BOX20, C-BOX25 si C-BOX30

230

**C-MBOX106** Maner pentru aplicatoare C-Box Columbia C-MBOX106 L=106cm

255

**C-MBOX92** Maner pentru aplicatoare C-Box Columbia C-MBOX92 L=92cm

220

**C-MBOX180** Maner pentru aplicatoare Columbia C-MBOX180

230

Cutie pentru aplicare pasta pe imbinari drepte (se utilizeaza cu MBOX)

**C-BOX25 C-BOX25** - latime 250 mm, greutate 1,43 kg

542

**C-BOX30 C-BOX30** - latime 300 mm, greutate 1,74 kg

550

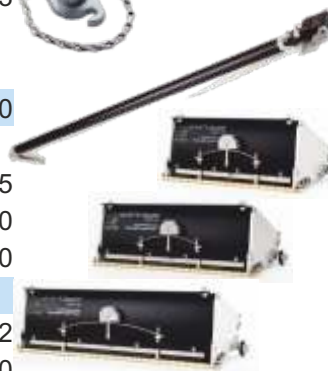



Cod produs	Descriere produs	Pret Euro (fara TVA)
4035834200001	<b>Chameleon</b> - Masina universala pentru slefuit, curatat, polisat, indepartat tapet, toate intr-o singura masina Putere motor 1 kW; viteza rotatie 150 - 570 rpm Greutate echipament slefuire: 2,2 kg	1.194
	<b>Discuri cu diametru Ø200 mm pentru 20000 Chameleon</b>	
	Discuri pentru curatarea rezidurilor de beton, rugina de pe cadre metalice (1)	
21200	Disc perie otel: fin, mediu sau dur (fig. 1)	123
21300	Disc special din otel: mediu sau dur (fig. 2)	123
21500	Disc din nylon: super fin, fin, dur (fig. 2)	123
	<b>Disc curatare fatade cladiri cu efect de marmura sau parchet</b>	
23400	Disc curatare granulometrie 80, 120, 180 (fig. 3)	17,0
23600	Disc polisare din piele foarte fin (fig. 4)	41,3
20100	Disc zgariere long life poate fi utilizat pentru indepartarea fibrei de sticla (fig. 5)	62,5
RK21700	Disc Widia pentru indepartarea tencuielii sau reziduu de adeziv (fig. 6)	198
RK2025200	Disc pentru netezirea betonului (aplicat cu lancea) (fig. 7)	53,5
RK2025000	Disc pentru netezirea betonului cu baza prindere (aplicat cu lancea)	61,6
4035834222508	<b>Pachet Premium pentru indepartarea tapetului: disc perforat (fig. 1) plus disc raschetare (fig. 4) + sine ghidaj (fig. 5) + placa pt ascutire lame discuri</b>	285
22700	Disc pentru netezirea betonului tip elicopter (fig. 1)	49,2
22600	Disc pentru nivelare cu lame tip mistrie (fig. 2)	102
22200	Discuri perforante pentru indepartarea tapetului (fig. 3)	149
22300	Discuri raschetare (fig. 4)	99,8
22210	Sine de ghidaj utilizare cu discurile de perforare si raschetare (fig. 5)	42,5
20700	Discuri sustinere cu velcro pentru montarea discurilor de slefuire, metalice (fig. 6)	36,5
4035834208168	Disc slefuire granulometrie 16, 4 buc. (pentru polistiren) (fig. 7)	15,5
4035834208243	Disc slefuire granulometrie 24, 4 buc. (pentru gips)	11,3
20840	Disc slefuire granulometrie 40, 6 buc. (pentru gips)	14,8
20860	Disc slefuire granulometrie 60, 6 buc. (pentru gips)	13,3
20880	Disc slefuire granulometrie 80, 6 buc.	12,4
20810	Disc slefuire granulometrie 100, 6 buc.	10,8
20812	Disc slefuire granulometrie 120, 6 buc.	10,8
28040	Discuri Jost granulometrie 40, 60, 80 (fig. 1)	26,8
28012	Discuri Jost granulometrie 120, 180, 220 (fig. 1)	22,0
27080	Grila raschetare granulometrie 80 (fig. 2)	19,8
27010	Grila raschetare granulometrie 100, 120, 180, 220 (fig. 2)	25,5
4035834224007	Disc abraziv metalic fin (fig. 3)	117
RK2023200	Disc abraziv metalic mediu (fig. 3)	121
RK22900	Disc abraziv metalic dur (fig. 3)	138

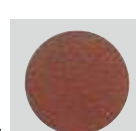
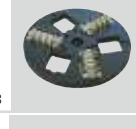
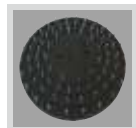
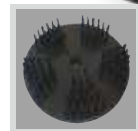

Cod produs	Descriere produs	Pret Euro (fara TVA)
4035834601006	<b>Heron</b> - Slefuitor telescopic - cel mai usor echipament telescopic Motor electric 1,5 kW, viteza rotatie 640-2.270 rpm Greutate echipament slefuire: 2,4 kg	1.137
60150	<b>Discuri cu diametru Ø 225mm pentru Heron</b> Suport baza Ø 225mm cu baza din spuma si arici (fig. 1)	64,5
62200	<b>Discuri pentru curatare si polis</b> Disc slefuire granulometrie 80 (fig. 2)	56,2
62000	Disc slefuire granulometrie 120 (fig. 2)	53,6
62100	Disc slefuire granulometrie 180 (fig. 2)	45,3
62800	Pad polisare foarte fin (fig. 2)	27,0
62900	Pad polishare din piele foarte foarte fin (fig. 3)	41,3
61100	<b>SuperPad discuri pentru vopsire profesionale si lacuire</b> SuperPad granulometrie 40, set 6 buc. (fig. 4)	20,8
61200	SuperPad granulometrie 60, set 6 buc. (fig. 4)	18,3
RK2061300	SuperPad granulometrie 80, set 6 buc. (fig. 4)	17,5
RK2061400	SuperPad granulometrie 100, set 6 buc. (fig. 4)	15,5
RK2061500	SuperPad granulometrie 120, set 6 buc. (fig. 4)	15,8
61600	SuperPad granulometrie 150, set 6 buc. (fig. 4)	15,8
69840	<b>Discuri Jost cu perforatii pentru extractia prafului - sistem brevetat</b> Disc slefuire granulometrie Jost 40, set 6 buc. (fig. 5)	29,3
69860	Disc slefuire granulometrie Jost 60, set 6 buc. (fig. 5)	27,8
4035834698808	Disc slefuire granulometrie Jost 80, set 6 buc. (fig. 5)	27,3
4035834698129	Disc slefuire granulometrie Jost 120, set 6 buc. (fig. 5)	26,4
4035834698181	Disc slefuire granulometrie Jost 180, set 6 buc. (fig. 5)	26,4
RK2069780	<b>Grila raschetare pentru tencuieli, materiale de umplere</b> Grila raschetare granulometrie 80, set 4 buc. (fig. 6)	22,0
69710	Grila raschetare granulometrie 100, set 6 buc. (fig. 6)	28,5
69712	Grila raschetare granulometrie 120, set 6 buc. (fig. 6)	28,5
69718	Grila raschetare granulometrie 180, set 6 buc. (fig. 6)	28,5
69722	Grila raschetare granulometrie 220, set 6 buc. (fig. 6)	28,5
60500	<b>Slefuirea lemnului, caramizilor, fibrei de sticla, beton si alte materiale</b> Disc abraziv metalic fin (fig. 7)	79,0
RK2060600	Disc abraziv metalic mediu (fig. 7)	80,9
RK2060700	Disc abraziv metalic dur (fig. 7)	90,5
RK2061005	Baza din spuma 7mm pentru sustinerea discului abraziv metalic	30,2
60300	<b>Pentru slefuirea betonului, sapelor etc.</b> Disc abraziv diamantat pentru beton, sape (fig. 8)	167
10000	Aspirator tip rucsac compatibil cu echipamentele Chameleon si Heron Aspirator electric - conectare la retea	781

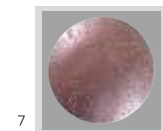
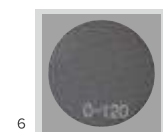
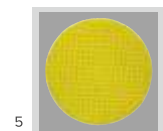
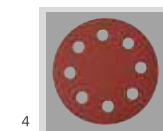
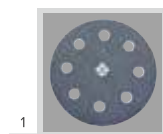



Cod produs

Descriere produs

Pret Euro (fara TVA)

RK93000 **SKATE** - Masina telescopica pentru finisare beton 1.157

**Nou!**

Disc slefuire Ø350 mm, motor electric 1 kW, turatie disc 85 - 340 rpm  
 Greutate echipament slefuire: 3,1 kg



**Accesorii SKATE**

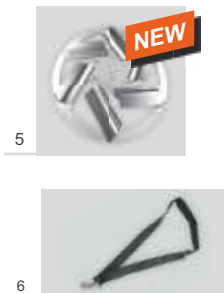

- |         |   |  |      |
|---------|---|--|------|
| 48900   | Disc Ø350 mm cu velcro (arici) (fig. 1)                               |     | 53,0 |
| 48100   | Disc polish perforat (fig. 2)   |    | 39,2 |
| 48200   | Disc polish Ø350 mm cu velcro (arici) (fig. 3)                        |    | 39,2 |
| 48900   | Disc (oțel inoxidabil) cu velcro, neted, „longlife” Ø 350 mm (fig. 4) |   | 114  |
| 34900   | Disc (oțel inoxidabil) cu velcro, neted, „longlife” Ø 215 mm (fig. 4) |   | 107  |
| 69110   | Baza disc (de folosit cu pad nr. 34900)                               |  | 18,2 |
| 93100   | Disc cu lame Ø 450 mm (fig. 5)  |   | 51,3 |
| RK05100 | Curea pentru umar (fig. 6)  |  | 46,4 |



RK1090200 **Piranha Cutter** - Echipament special crearea santurilor pentru cabluri 1.091

Disc 115 mm sau 125 mm. Putere motor 1,5 kW; turatie 2.800 - 9.100 rpm  
 Greutate echipament taiere 1,7 kg

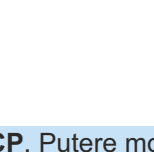

- |           |  |  |      |
|-----------|--|--|------|
| RK2090120 | Disc taiere diamantat Ø 115mm (fig. 2) |   | 54,0 |
| RK2090121 | Disc taiere diamantat Ø 125mm (fig. 2) |  | 60,2 |
| RK05100   | Curea pentru umar (fig. 3)             |   | 46,4 |

4007430250124 **Aspirator electric uscat-umed ASR 35 M SCP**. Putere motor 1,4 kW - 919

**Nou!**

230V, Volum rezervor 35 l, debit aer 262,8 m³/h. Greutate 16 kg.  
 Priză pentru conectarea unei unelte electrice (ex.: slefuitor);  
**AutoCleanPlus**: curatare automata a filtrului MPulse in timpul utilizării continue.



# SCHELE | COFRAJE | PANOURI

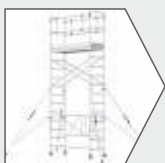

**Schela mobila profesionala Protube**  
Pagina 77



**Scari si schele profesionala**  
Pagina 81



**Panou galben**  
Pagina 84



**Panou TEGO**  
Pagina 85



**Grinda H20**  
Pagina 86



**Accesorii pentru cofraje**  
Pagina 87



**Accesorii pentru cofraje**  
Pagina 88



**Popi metalici si trepiezi**  
Pagina 92

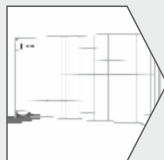

**Sistem mobil EU2 Garduri**  
Pagina 93



**Tubulatura evacuare deseuri | Parapeti rutieri**  
Pagina 94



# Schela mobila profesionala din aluminiu ProTUBE L

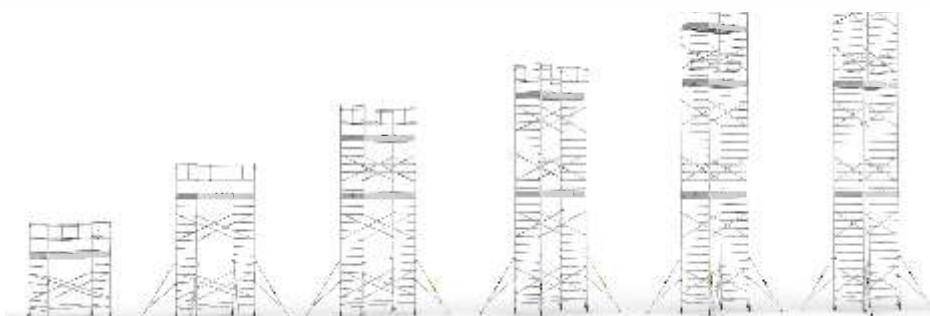

Schela mobila AL, ProTube L, dim. platforma = 120x240cm, incl. 1 plan lucru Pret Euro (fără T.V.A.)	<b>PROTUBE L4</b> Hlucru = 4,1m	<b>PROTUBE L6</b> Hlucru = 6,2m	<b>PROTUBE L8</b> Hlucru = 8,3m	<b>PROTUBE L10</b> Hlucru = 9,8m	<b>PROTUBE L12</b> Hlucru = 12,5m	<b>PROTUBE L14</b> Hlucru = 13,8m
	<b>1.544</b>	<b>2.177</b>	<b>2.734</b>	<b>3.046</b>	<b>3.669</b>	<b>3.981</b>

Descriere elemente Schela ProTube L	Pret unitar € (fără T.V.A.)	Numar elemente Schela ProTube L					
Cadru schela 7 trepte PT223M Cod: 8697817587118	<b>126,8</b>	2	4	6	6	10	10
Cadru schela 5 trepte PT163M Cod: 8697817588351	<b>93,6</b>	0	0	0	2	0	2
Ranforsare orizontala PT259Y Cod: 8697817587170	<b>29,8</b>	2	2	8	8	14	14
Ranforsare diagonala PT275C Cod: 8697817587156	<b>31,1</b>	4	8	12	16	20	24
Podea cu trapa PT258KP Cod: 8697817587132	<b>213,0</b>	1	1	1	1	1	1
Podea fara trapa PT258K Cod: 8697817587149	<b>193,0</b>	1	1	1	1	1	1
Roata cu frana PT200TE Cod: 8697817587194	<b>76,6</b>	4	4	4	4	4	4
Parapet de capat PT110K Cod: 8697817587125	<b>53,3</b>	2	2	2	2	2	2
Parapet lateral PT259H Cod: 8697817587163	<b>66,3</b>	2	2	2	2	2	2
Stabilizator PT276PA Cod: 8697817587187	<b>63,8</b>	0	4	4	4	4	4
Protectie picioare PT302TM Cod: 8697817587200	<b>155,1</b>	1	1	1	1	1	1

## Optional:

Plan de lucru suplimentar: PT258KP + PT258K + PT302TM **541 € (+TVA)**



# Schela mobila profesionala din aluminiu ProTUBE S

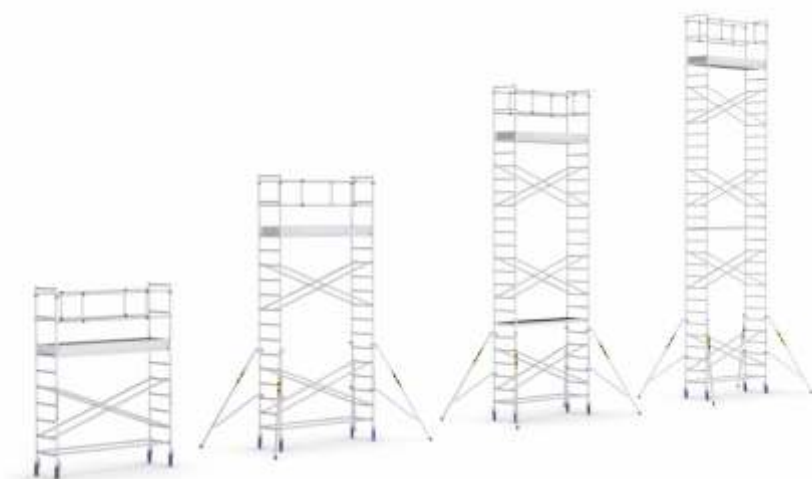

Schela mobila AL, ProTube S, dim. platforma = 60x240cm, incl. 1 plan lucru Pret Euro (fără T.V.A.)	<b>PROTUBE S4</b> Hlucru = 4,1m	<b>PROTUBE S6</b> Hlucru = 6,2m	<b>PROTUBE S8</b> Hlucru = 8,3m	<b>PROTUBE S10</b> Hlucru = 10,4m
	<b>1.224</b>	<b>1.782</b>	<b>2.085</b>	<b>2.388</b>



Descriere elemente Schela ProTube S	Pret unitar € (fără T.V.A.)	Numar elemente Schela ProTube S			
		S4	S6	S8	S10
Cadru schela 7 trepte PTS223M Cod: 8697817588368	<b>89,2</b>	2	4	6	8
Ranforsare orizontala PT259Y Cod: 8697817587170	<b>30,0</b>	2	2	2	2
Ranforsare diagonala PT275C Cod: 8697817587156	<b>31,1</b>	4	8	12	16
Podea cu trapa PT258KP Cod: 8697817587132	<b>213,0</b>	1	1	1	1
Roata cu frana PT200TE Cod: 8697817587194	<b>76,6</b>	4	4	4	4
Parapet de capat PTS110K Cod: 8697817588399	<b>42,6</b>	2	2	2	2
Parapet lateral PT259H Cod: 8697817587163	<b>66,3</b>	2	2	2	2
Stabilizator PT276PA Cod: 8697817587187	<b>81,6</b>	0	4	4	4
Protectie picioare PTS302TM Cod: 8697817588436	<b>124,3</b>	1	1	1	1

### Optional:

Plan de lucru suplimentar: PT258KP + PTS302TM **326 € (+TVA)**



# Schela mobila profesionala din aluminiu ProTUBE F



Schela mobila AL, ProTube F, dim. platforma = 60x180cm, incl. 1 plan lucru Pret Euro (fără T.V.A.)	PROTUBE F90 Hlucru = 2,7m	PROTUBE F180 Hlucru = 3,6m	PROTUBE F360 Hlucru = 5,4m	
	427	788	1.317	
Descriere elemente Schela ProTube F	Pret unitar € (fără T.V.A.)	Numar elemente Schela ProTube F		
Etaj de baza PT192M Cod: 8697817589266	202,8	1	1	1
Cadru schela 6 trepte PTF223ME Cod: 8697817588382	78,0	-	-	2
Pin conector cadre PT18C Cod: 8697817589051	3,2	-	4	8
Ranforsare orizontala PTF182Y Cod: 8697817588412	24,7	-	1	1
Ranforsare diagonala PTF202C Cod: 8697817588283	26,4	-	1	5
Podea cu trapa PTF183KP Cod: 8697817589303	167,7	1	1	1
Roata cu frana PT125TE Cod: 8697817588450	14,2	4	4	4
Parapet de capat PTS110K Cod: 8697817588399	42,6	-	2	2
Parapet lateral PTF182H Cod: 8697817588467	53,8	-	2	2
Stabilizator PT276PA Cod: 8697817587187	63,8	-	-	4
Protectie picioare PTF180TM Cod: 8697817588290	103,9	-	1	1

### Optional:

Plan de lucru suplimentar: PTF183KP + PTF180TM 269 € (+TVA)





# Schele profesionale din aluminiu

Cod produs

Descriere produs

Pret Euro (fara TVA)

8697817590910 **ProTUBE Mini7** Schela mobila profesionala din aluminiu H lucru 6,8m, 1.505

**Nou!**

plan antiderapant 60x100cm, roti pivotante cu blocator, stabilizatori ajustabili,



	m	m	m	cm	cm	kg
	4,86	6,8	6,28	113x73	283x243	



**Nou!**

## SCHELA TURN ProTOWER

SCHELA TURN ProTOWER	MODEL	TURN L6	TURN L7	TURN L9	TURN L11	TURN L12
	Pret Euro (fără T.V.A.)	2.777	3.324	3.996	4.619	5.234
	Inaltime la ultima treapta	5,4m	7,2m	9,0m	10,8m	12,6m
	Inaltime schela	7m	8,6m	10,2m	12m	13m
Descriere elemente Schela turn ProTOWER		Numar elemente Schela turn ProTOWER				
Scara cu balustrade H1,8m PT320ME, Cod: 8697817591306		3	4	5	6	7
Baza reglabila filetata 750mm vopsita, Cod: CG059009		4	4	4	4	4
Ancoraj 40cm cu pini, Cod: RO0008402		2	3	4	5	6
Morseta fixa octogonala, Cod: CG0003611		2	3	4	5	6
Cadru schela 7 trepte PT223M Cod: 8697817587118		4	4	4	10	10
Cadru schela 5 trepte PT163M Cod: 8697817588351		2	4	6	0	2
Ranfarsare orizontala PT259Y Cod: 8697817587170		8	8	12	14	14
Ranfarsare diagonala PT275C Cod: 8697817587156		12	16	18	20	24
Podea fara trapa PT258K Cod: 8697817587149		1	1	1	1	1
Parapet de capat PT110K Cod: 8697817587125		2	2	2	2	2
Parapet lateral PT259H Cod: 8697817587163		2	2	2	2	2

# Scari / Schele din aluminiu

Cod produs	Descriere produs	Pret Euro (fara TVA)
8697817590057	<b>TeleSafe 005XL</b> - Schela mobila completa, Hlucru = 5,60m, plan 60x155cm	938
8697817590071	<b>TeleSafe 007XL</b> - schela mobila completa, Hlucru = 7,00m, plan 60x155cm	1.092
8697817590088	<b>TeleSafe 008XL</b> - schela mobila completa, Hlucru = 7,85m, plan 60x155cm	1.356

**TeleSafeXL**



**Optionale:**

8697817591313	Kit 4 stabilizatoare 1.800 mm TelesafeXL (1)	15
	PLT155x60 Platforma de lucru pentru TeleSafe XL (2)	636
	TEK45678XL Protectie picioare pentru platforma de lucru TeleSafe XL (3)	236
	Q1710100 Ranforsare orizontala pentru TeleSafe XL (4)	18,2

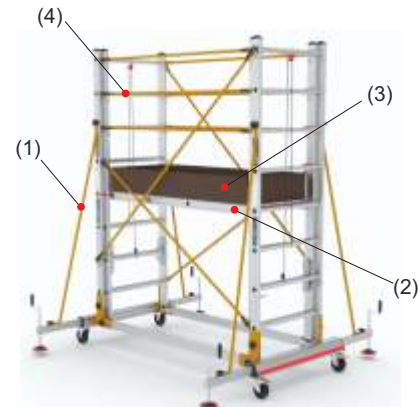

8697817585671	<b>TeleSM 460</b> - Schela mobila completa, Hlucru = 4,74m, plan 60x155cm	826
8697817585688	<b>TeleSM 640</b> - schela mobila completa, Hlucru = 6,70m, plan 60x155cm	968

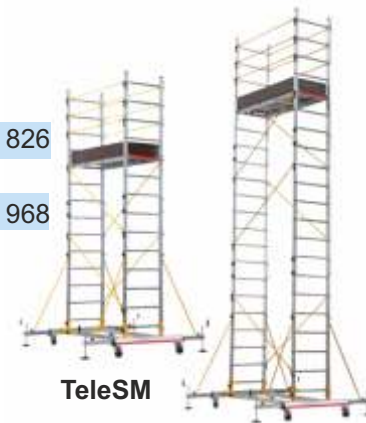

**TeleSM**

8697817585855	<b>TelePL - PL002</b> Scara dubla si schela fara roti, Hlucru = 4,40m, plan 45x155cm	352
---------------	--	-----



# Platforme mobile profesionale din aluminiu

8697817585787 **Platforma EP4** - Platforma mobila cu 4+1trepte, Hlucru=3,05m podea 60x60cm

826

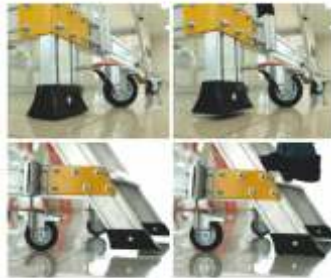

EP4

8697817588672 **Platforma RD28** - Platforma mobila profesionala cu 3+1trepte, Hlucru=2,8m podea 60x50cm

548

8697817585701 **Platforma RD33** - Platforma mobila profesionala cu 5+1trepte, Hlucru=3,3m podea 60x50cm

620

8697817585718 **Platforma RD38** - Platforma mobila profesionala cu 7+1trepte, Hlucru=3,8m podea 60x50cm

735



RD28

RD33

RD38



Certificate  
EN 131-7  
Norm



Foia cofrantă este panoul tradițional de cofrare culoare galbenă și vine, în principal, pentru segmentul de construcții rezidențiale. Panoul de foaie cofrantă are o structură solidă, fiind compus din trei straturi încleiate și tratate la suprafață cu rășină melaminică rezistentă la apă.

Sunt disponibile diverse dimensiuni, grosimi standard 21 și 27mm, la cerere se pot livra și grosimi speciale. Poate fi utilizată atât pentru pereți cât și pentru planșee, suprafața betonului finit având aspect curat.

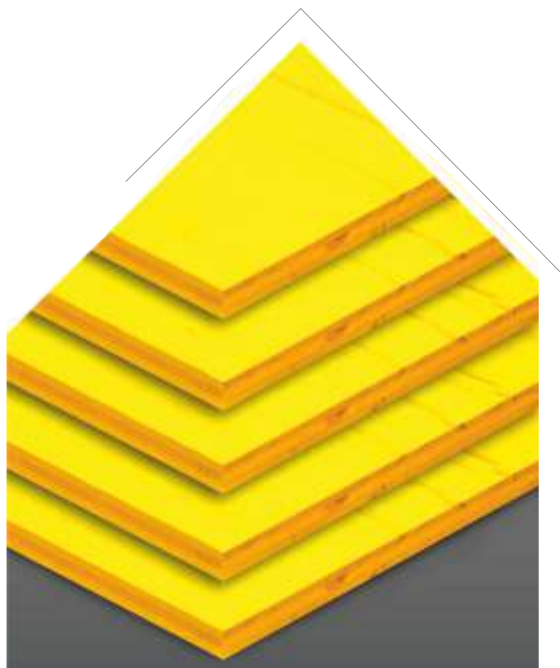

Panou galben stratificat de 21 mm sau 27 mm.



Panou galben cant metalic 21mm



Panourile lățime 50cm sunt disponibile atât fără profil de protecție a marginilor, cât și cu profil metalic de protecție pe lățime.

Panoul de cofraj din plastic este fabricat din polipropilenă de înaltă calitate. Se caracterizează prin rigiditate ridicată, rezistență la căldură, rezistență la coroziune și are o rezistență la impact mult mai mare. Nu este necesar ulei de deformare, iar dezamblarea cofrajului este întotdeauna ușoară.

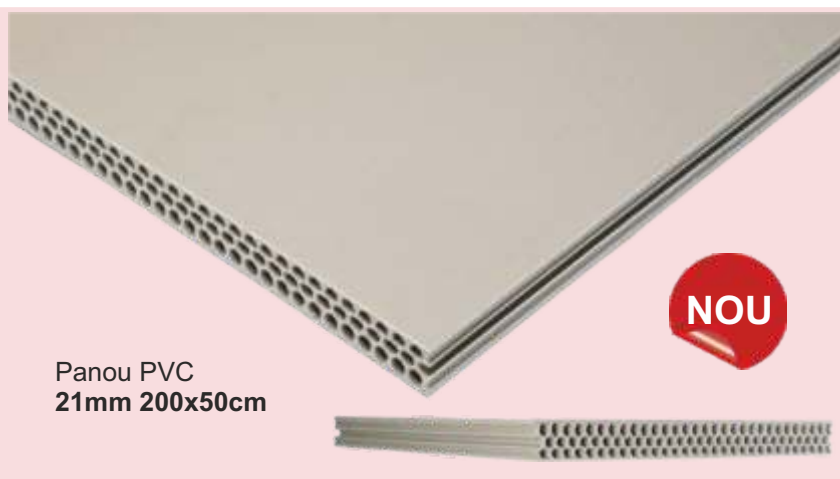

Panou PVC 21mm 200x50cm

**NOU**

## Foie cofrantă

COD	Denumire	Solicita oferta!
CG11949	Panou galben 21mm 200x50cm	
CG11949-C	Panou galben cant metalic 21mm 200x50cm	
CG11953	Panou galben 27mm 250x50 cm	
CG11952	Panou galben 27mm 200x50 cm	
CG0009295	Panou PVC 21mm 200x50cm	

Panou cofrare tip TEGO este confecționat din furnire de plop suprapuse, în straturi, adeziva cu adezivi fenolici rezistenți la apă, având suprafețele acoperite cu film fenolic de culoare negru sau maro.

Panou este folosit îndeosebi la cofrare, în construcții, pentru care oferă un număr mare cicluri de turnare.

Panou stratificat este un semifabricat din lemn sub formă de placă, realizat prin incleierea sub presiune a unui număr de foi de furnir suprapuse, fiecare strat având fibră lemnoasă dispusă perpendicular pe straturile adiacente, folosit la fabricarea mobilelor, a ambalajelor, a ambarcațiunilor, că suport pentru parchetul adezivat sau aplicat, cofrarea în construcții în vederea turnării betoanelor, etc.

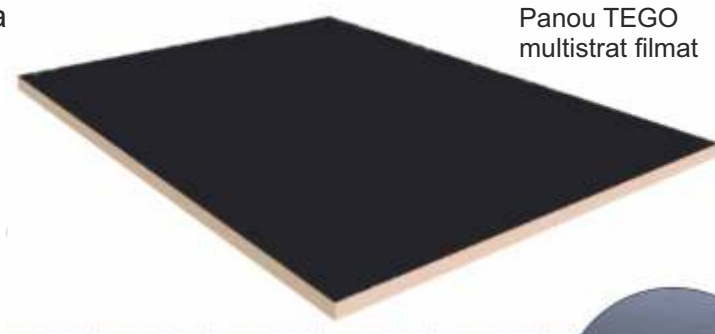

Panou TEGO multistrat filmat

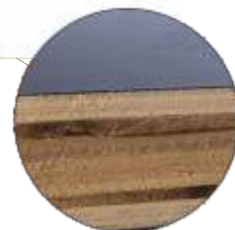

Nici un alt produs din lemn nu poate fi utilizat pe o scară atât de largă ca panoul.

Proprietățile deosebite oferite de placaj sunt: rezistență mecanică, elasticitate, inconviere, imunitate ridicată la schimbările bruște ale temperaturii sau umidității, fac din acest material unul dintre cele mai utilizate.

## Ofertă vânzare foaie cofrantă

COD	Denumire	Solicita oferta!
CGTEGO-2/2.97	Panou multistrat (Tego) 21mm 244 x 122 cm, nereciclat, plop	
CGTEGO-1/2.97	Panou multistrat (Tego) 20 mm 244 x 122 cm, reciclat, plop	
CGTEGO-2/1.56	Panou multistrat (Tego) 21mm 250x62.5cm, nereciclat, plop	



Grinzi susținere din lemn.

## Grindă lemn H20

COD	Denumire	Solicita oferta!
CG20050	Grinda H20 2,15m	
CG0009375	Grinda H20 2,45m	
CG20049	Grinda H20 2,65m	
CG20041	Grinda H20 2,90m	
CG20042	Grinda H20 3,30m	





Paolina este solutia ideala pentru curatarea panourilor de cofraj din lemn latime de 50 cm, putand curata fara probleme cele doua fete vizibile ale placilor de cofraj si canturile acestora.

În plus, Paolina dispune de role de sfărâmare, lame duble pe fiecare parte, perii de praf și sistem automat de aplicare și finisare a decofrantului.

„Paolina” este o mașină ce se produce de peste 28 de ani, si are peste 8.000 de unități produse și vândute în toată Europa.



LA PAOLINA  
Masina de curatat panouri  
COD: PL1003078

**Solicita oferta!**



### Masina de curatat panori LA PAOLINA

Număr de role de sfărâmare	2 orizontale + 2 verticale
Numar de lame curatare	6 orizontale + 4 verticale
Numar de perii de praf	2
Număr lame cauciuc pentru aplicare	2 orizontale + 2 verticale
Putere motor 230V	0,75 Kw / 1CP
Puterea pompei 230V	0,11 kW
Viteza de curatare	780 ml/h
Grosimea min./max.	22 / 37 mm
Latime	500 mm
Capacitate rezervor decofrant	30 litri
Nivel acustic	74 dB
Dimensiuni mașină în faza de lucru	2.730 / 780 / 1.040 mm
Greutate	225 kg

BISCUIT H15x45  
COD: RO0009296



Set 500 buc. **15,2 €**

BISCUIT H20x45  
COD: RO0009297



Set 500 buc. **21,4 €**

BISCUIT H25x50  
COD: RO0009298



Set 500 buc. **34,2 €**

BISCUIT H30x50  
COD: RO0009299



Set 500 buc. **35,7 €**

ROZETĂ H20  
COD: RO0009300



Set 500 buc. **16,6 €**

ROZETĂ H25  
COD: RO0009301



Set 500 buc. **17,7 €**

ROZETĂ H25-XL  
COD: RO0009302



Set 500 buc. **13,7 €**

ROZETĂ H30  
COD: RO0009303



Set 500 buc. **18,3 €**

## SOLICITA OFERTA!

ROZETĂ H35  
COD: RO0009304



Set 500 buc. **34,0 €**

ROZETĂ H40  
COD: RO0009305



Set 250 buc. **17,9 €**

ROZETĂ H50  
COD: RO0009306



Set 250 buc. **24,4 €**

FAGURE H30  
COD: RO0009307



Set 500 buc. **31,5 €**

FAGURE H50  
COD: RO0009308



Set 250 buc. **43,0 €**

FAGURE H70  
COD: RO0009309



Set 250 buc. **72,9 €**

TRAPEZOIDAL  
H40-50  
COD: RO0009312



Set 250 buc. **26,7 €**



CILINDRIC CH25  
COD: RO0009310



Set 500 buc. 16,0 €

CILINDRIC CH50  
COD: RO0009311



Set 500 buc. 44,5 €

ARMĂTURĂ H25  
COD: RO0009313



Set 500 buc. 23,6 €

ARMĂTURĂ H50  
COD: RO0009314



Set 250 buc. 20,6 €

CON CU DOP 22MM  
COD: RO0009315



Set 500 buc. 15,8 €

CON fără DOP  
COD: RO0009316



Set 500 buc. 12,1 €

ȚEAVĂ PVC PENTRU PROTEJAREA TIJEI  
FILETATE, Ø22MM, L=2M  
COD: CGPPD22



0,39 €

## SOLICITA OFERTA!

PROFIL  
TRIUNGHIULAR  
L=2M

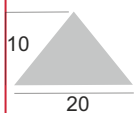

20MM, L=2ML  
COD: ROPST20  
Preț/ml  
0,27 €

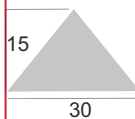

30MM, L=2ML  
COD: ROPST30  
Preț/ml  
0,42 €



DISTANȚIERI FIER-BETON ARMARE PLACĂ NLF,  
L=2M



H20mm  
COD: RO480590003  
0,54 €

H25mm  
COD: RO480590015  
0,68 €

H50mm  
COD: RO480590010  
1,6 €

CRAVATE ZINCATE  
15-45CM  
COD: CGGCRZ



Set 4 buc. 31,8 €

CAPAC PROTECȚIE  
ROȘU  
Ø 16MM  
COD: ROPCPF620



0,16 €

PROFIL U ZINCAT  
50CM  
COD: CGSUZ50



1,3 €

PROFIL U ZINCAT  
100CM  
COD: CGSUZ100



2,6 €

PROFIL U ZINCAT  
150CM  
COD: CGSUZ150



5,6 €



PANĂ METALICĂ  
COD: 3877002091254



Set  
100 buc. 19,0 €

DISTANȚIER  
METALIC 15CM  
COD: 3877002091025



Set  
100 buc. 9,05 €

DISTANȚIER  
METALIC 20CM  
COD: CGDT20



Set  
100 buc. 10,5 €

DISTANȚIER  
METALIC 25CM  
COD: 3877002091049



Set  
100 buc. 12,0 €

DISTANȚIER  
METALIC 30CM  
COD: 3877002091056



Set  
100 buc. 13,6 €

## SOLICITA OFERTA!

DISTANȚIER  
METALIC 35CM  
COD: 3877002091063



Set  
100 buc. 15,3 €

DISTANȚIER  
METALIC 40CM  
COD: 3877002091070



Set  
100 buc. 17,7 €

DISTANȚIER  
METALIC 45CM  
COD: CGDT45



Set  
100 buc. 19,2 €

DISTANȚIER  
METALIC 50CM  
COD: 3877002091094



Set  
100 buc. 21,0 €

DISTANȚIER  
METALIC 55CM  
COD: 3877002091100



Set  
100 buc. 38,8 €

DISTANȚIER  
METALIC 65CM  
COD: 3877002091124



Set  
100 buc. 26,5 €

DISTANȚIER  
METALIC 85CM  
COD: 3877002091162



Set  
100 buc. 33,3 €

CLEMĂ CU PANĂ  
COFRAJE  
COD: Cg54600



1,5 €



CHEIE DE  
TENSIONARE  
COD: CG54610



17,0 €

PIULIȚĂ FIXĂ DW15  
COD: CGA121Z



1,7 €

TIRANT DW15  
L=300CM  
Ø 16MM  
COD: CGPF300N



9,1 €

## Decofrant soluție **ALCHIOIL 100**

- Ambalaj: bidoane de 10l, 25l
- Ulei sintetic, ajută / înlesnește procesul de decofrare
- Se utilizează pentru acoperirea panourilor de cofraj cu foaie TEGO sau alte materiale, foaie galbenă, etc.
- **Nu se diluează**
- **Acoperire conform recomandări producător: 50 – 60 m<sup>2</sup>/litru (nediluat)**
- Se aplică cu trafalet sau prin pulverizare cu pompă, înainte de fiecare turnare



**Bidon 10L**

COD: CGPFPR025

**26,8 €**

**Bidon 25L**

COD: CGPFPR008

**74,1 €**

**Bidon 210L**

COD: CGPFPR031

**607 €**

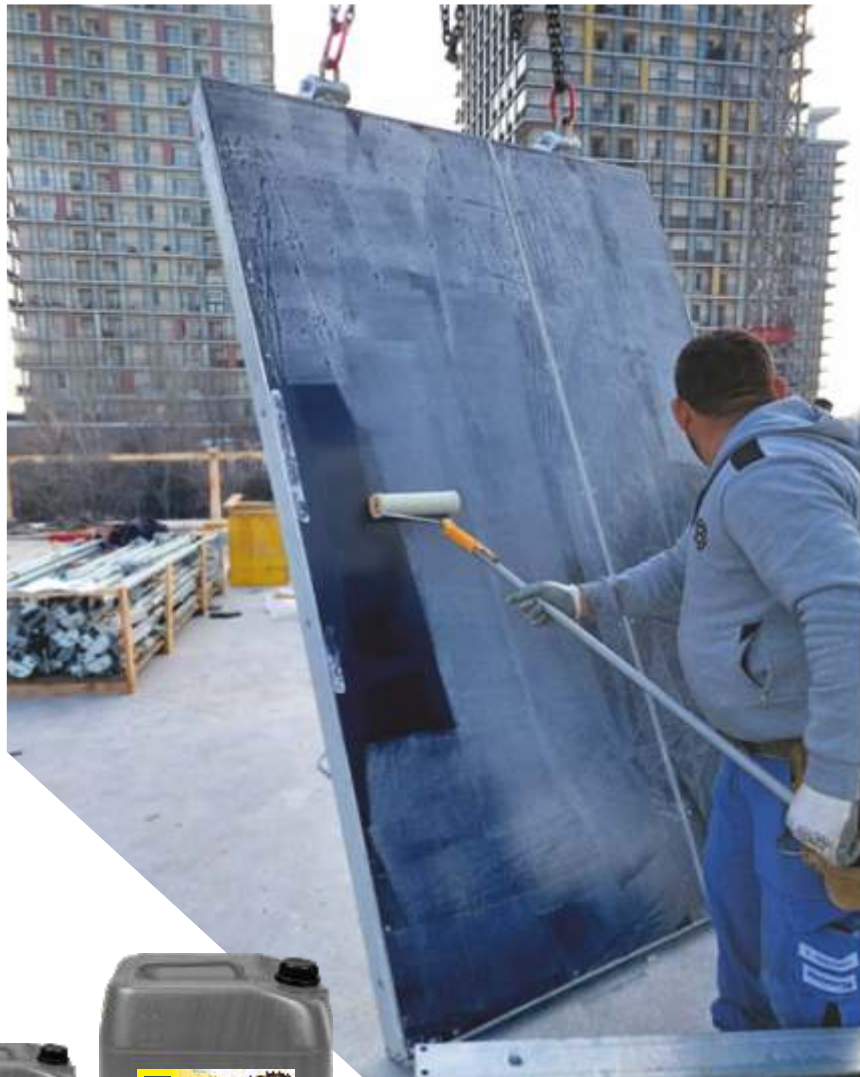

## Decofrant soluție **E20**

Emulsie pentru decofrarea betoanelor și pentru tratamentul antiadeziv al tuturor tipurilor de cofraje (tego, metal, plastic, lemn).

- Produsul este pregătit pentru utilizare și se aplică prin pulverizare sau pensulare/roluire.
- **Produsul se diluează în raport 1:1**
- **Consum 2-4 litri diluați/100 mp**
- Ambalaj: bidoan de 10l și 20l



**Bidon 10L**

COD: RO0009469

**18,6 €**

**Bidon 20L**

COD: RO0009470

**37,0 €**

ELEMENT DE COMPENSARE PENTRU PANOU GALBEN L=62CM, H=53CM  
COD: CGCOMPP



**SOLICITA OFERTA!**

ELEMENT DE COMPENSARE PENTRU PANOU GALBEN L=40/40CM, H=53CM  
COD: CGCOMPY



**SOLICITA OFERTA!**



### Popii metalici:

- Sunt fabricați în conformitate cu Standard UNI EN1065;
- Definiție: durabili, siguri, ușor de reglat;
- Popii CONDOR sunt însoțiți de diagramă de sarcină caracteristică.

### Accesorii pentru popii

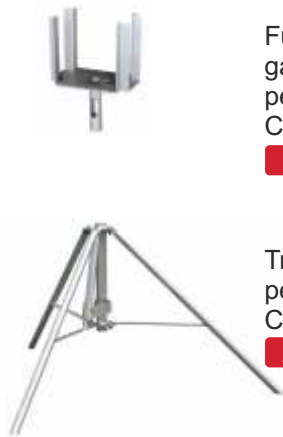

Furcă cruce galvanizată pentru grindă H20  
COD: CG0006392

**6,0 €**

Trepied zincat pentru popii  
COD: CG0049005

**23,2 €**



**DISPONIBIL  
ȘI LA  
ÎNCHIRIERE**



Specificații tehnice popii metalici galvanizati			
	EK29-3200	EK29-3600	EK29-4000
COD produs	CGEK29-3200	CGEK29-3600	CGEK29-4000
Diametru tub extern	Ø 56 mm		
Diametru tub intern	Ø 48,3 mm		
Lungime min.	1.800 mm	2.000 mm	2.200 mm
Lungime max.	3.200 mm	3.600 mm	4.000 mm
Capacitate kN	29-15,6 kN	29-11,4 kN	29-10,0 kN

**15,4 €**

**16,5 €**

**17,4 €**

**Nou!**



Specificații tehnice popii metalici vopsiti		
	QS20-4500	QS20-5000
COD produs	CGQS20-4500	CGQS20-5000
Diametru tub extern	Ø 56 mm	
Diametru tub intern	Ø 48,3 mm	
Lungime min.	2.500 mm	2.500 mm
Lungime max.	4.500 mm	5.000 mm
Capacitate kN	20-7,2 kN	20-7,2 kN

**17,4 €**

**18,6 €**

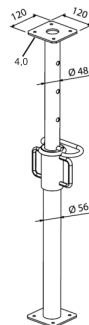

**Nou!**



### Caracteristici:

- Siguranță;
- Manevrabilitate facilă;
- Capacitate ridicată de încărcare;
- Raport optim calitate-preț;
- Calitate superioară;
- Înălțime reglabilă, cu blocaj.



CGA04942/212/T

## Sistem mobil EU 2

63,4

Dimensiunea panoului: 3.530 × 2.000 mm  
 Diametrul firului: 3 mm orizontal - 2,8 mm vertical  
 Dimensiunea ochiului: 100 × 250 mm  
 Diametrul tubular: 40 mm orizontal - 27 mm vertical  
 Materiale de finisare: țevă și sârmă galvanizate la cald  
 Greutate: ~ 12 kg

### Caracteristici cheie:

- confectionate din oțel galvanizat
- ranforsare la 4 colturi
- structura rezistentă
- finisaj de calitate superioară
- instalare și manevrare facilă
- siguranță



Ranforsare la 4 colturi.



Clema pentru conexiune superioară cu următorul panou

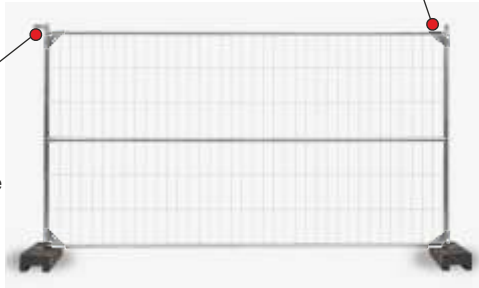

Inchiriere sistem complet de gard (panou, baza, clema) = 1,45 € (fara TVA) /ml/luna  
 Nu include transport.

CGE212/B

## Sistem mobil EU 1/B

39,8

Dimensiunea panoului: 3.530 × 2.000 mm  
 Diametrul firului: 3,1 mm orizontal - 2,8 mm vertical  
 Dimensiunea ochiului: 100 × 250 mm  
 Diametrul tubular: 42 mm vertical - 27 mm orizontal  
 Materiale de finisare: țevă și sârmă galvanizate la cald  
 Greutate: ~ 16,3 kg



CGE212/BIH

## Sistem mobil EU 1/BIH

28,8



Dimensiunea panoului: 3.300 × 2.000 mm  
 Diametrul firului: 3,1 mm orizontal - 2,8 mm vertical  
 Dimensiunea ochiului: 100 × 250 mm  
 Diametrul tubular: 42 mm vertical - 27 mm orizontal  
 Materiale de finisare: țevă și sârmă galvanizate la cald



CGE015

## Baza CLS, beton armat, ~ 23 kg

5,7

Cel mai comun suport pentru susținerea gardurilor.  
 Realizat din beton cu armare interioară cu sarma de otel adecvata cu aderența îmbunătățită.



CGE019

## Clema de conexiune din otel galvanizat

3,5

Este folosit pentru a preveni scoaterea panoului de pe baza de susținere.  
 Indispensabil atunci când se utilizează bare de contravântuire.



Cod produs	Descriere produs	Pret Euro (fara TVA)
TE0009460	Tub standard de evacuare 1.060 mm (include lanturi) - Negru	39
TE0009461	Cuva de incarcare standard 650 mm - Negru	65
TE0001119	Tub standard de evacuare 1.060 mm (include lanturi) - Galben	46,0
TE0001120	Cuva de incarcare standard 650 mm - Galben	76,0
TE0007055	Cuva de incarcare prelungita 1.030 mm - Galben	94,0
TE0006226	Cuva de incarcare cu separator - Galben	84,5
TE0001121	Suport pentru cuva de incarcare - Zincat	79,0
TE0006196	Lant complet pentru tubulatura evacuare deseuri (1 bucata)	7,2
TE0006225	Dispozitiv incetinire deseuri	19,5
TEE001LA	Protectie metalica pentru tubulatura	85
TEE001TV	Recipient dreptunghiular din polyuretana cu manere capacitate 180 l	102
TEE001BB	Bena basculanta polietilena 70L/150 kg	94

### Parapeti rutieri mobili

TE0001711	Parapet lestable NJ60/11 din plastic rosu 1.000x400x600 mm	42
TE0001712	Parapet lestable NJ60/11 din plastic alb 1.000x400x600 mm	37,5
TE0002810	Parapet lestable NJ70/11 din plastic rosu 1.000x400x700 mm	42
TE0002811	Parapet lestable NJ70/11 din plastic alb 1.000x400x700 mm	42



# GENERATOARE DE CURENT

**SEACI**



Generatoare de curent seria Lite  
Pagina 96



Generatoare de curent seria Top  
Pagina 97



Generatoare de curent seria EVO  
Pagina 99



Generatoare tip inverter - COVER  
Pagina 100



Generatoare tip inverter - OPEN  
Pagina 100



Generatoare pentru sudura  
Pagina 101



Generatoare de curent rezidentiale  
Pagina 102



Generatoare de curent rezidentiale  
Pagina 103



Motopompe  
Pagina 104

**KOSHIN**



Pompe submersibile electrice  
Pagina 105



Motopompe ape curate/murdare  
Pagina 106

**FRIGGERI**



Aparataj electric  
Pagina 108



Cod produs	Descriere produs	Pret Euro (fara TVA)
6426390839053 	<b>SC-1250 LITE</b> Putere max. 1,0kW, 230V-50Hz, Motor benzina 3 cp Rezervor carburant 6L; Autonomie 12,5 ore - 1/2 incarcare/consum Contor ore/voltmetru/frecventa; Senzor lipsa ulei cu led rosu si oprire motor Greutate: 26kg; Dimensiuni: 510x390x450mm	216
6426390839060 	<b>SC-1250E LITE</b> Idem, pornire electrica, baterie inclusa	260
6426390839237 	<b>SC-2500 LITE</b> Putere max. 2,2kW, 230V-50Hz, Motor benzina 5,5 cp Rezervor carburant 15L; Autonomie 12,5 ore - 1/2 incarcare/consum Contor ore/voltmetru/frecventa; Senzor lipsa ulei cu led rosu si oprire motor Greutate: 42kg; Dimensiuni: 625x490x510mm	263
6426390839251 	<b>SC-3500 LITE</b> Putere max. 3,1kW, 230V-50Hz, Motor benzina 7 cp Rezervor carburant 15L; Autonomie 12,5 ore - 1/2 incarcare/consum Contor ore/voltmetru/frecventa; Senzor lipsa ulei cu led rosu si oprire motor Greutate: 48kg; Dimensiuni: 625x480x500mm	298
6426390839268 	<b>SC-3500E LITE</b> , idem, pornire electrica, baterie inclusa	340
6426390839282 	<b>SC-4000 LITE</b> Putere max. 3,8kW, 230V-50Hz, Motor benzina 7,5 cp Rezervor carburant 15L; Autonomie 13,5 ore - 1/2 incarcare consum Contor ore/voltmetru/frecventa; Senzor lipsa ulei cu led rosu si oprire motor Greutate: 50kg; Dimensiuni: 625x490x510mm	363
6426390839350 	<b>SC-6000 LITE</b> Putere max. 5,5kW, 230V-50Hz, Motor benzina 13 cp Rezervor carburant 25L; Autonomie 13,5 ore - 1/2 incarcare consum Contor ore/voltmetru/frecventa; Senzor lipsa ulei cu led rosu si oprire motor Greutate: 81kg; Dimensiuni: 730x556x610mm	523
6426390839381 	<b>SC-9000E LITE</b> , Putere max. 7,5 kW, 230V-50Hz, Motor benzina 16 cp Rezervor carburant 25 l; Autonomie 10,5 ore - 1/2 incarcare consum Contor ore/voltmetru/frecventa, <b>demaraj electric (acumulator inclus)</b> Senzor lipsa ulei cu led rosu si oprire motor Roti si manere pentru transport incluse Greutate: 90kg; Dimensiuni: 686x526x550mm	700





Cod produs	Descriere produs	Pret Euro (fara TVA)
6426390839220	<b>SC-2500 TOP</b> Putere max. 2,2kW, 230V-50Hz, Motor benzina 5,5 cp Rezervor carburant 15L Autonomie 12,5 ore - 1/2incarcare/consum Contor ore/voltmetru/frecventa Senzor lipsa ulei cu led rosu si oprire motor Greutate: 42kg; Dimensiuni: 625x490x510mm	299
6426390839244	<b>SC-3500 TOP</b> Putere max. 3,1kW, 230V-50Hz, Motor benzina 7 cp Rezervor carburant 15L Autonomie 12,5 ore - 1/2incarcare/consum Contor ore/voltmetru/frecventa Senzor lipsa ulei cu led rosu si oprire motor Greutate: 48kg; Dimensiuni: 625x480x500mm	346
6426390839275	<b>SC-4000 TOP</b> Putere max. 3,8kW, 230V-50Hz, Motor benzina 7,5 cp Rezervor carburant 15L Autonomie 13,5 ore - 1/2incarcare consum Contor ore/voltmetru/frecventa Senzor lipsa ulei cu led rosu si oprire motor Greutate: 50kg; Dimensiuni: 625x490x510mm	398
6426390839312	<b>SC-5000 TOP</b> Putere max. 4,5kW, 230V-50Hz, Motor benzina 11 cp Rezervor carburant 25L Autonomie 13,5 ore - 1/2incarcare consum Contor ore/voltmetru/frecventa Senzor lipsa ulei cu led rosu si oprire motor Roti si manere pentru un transport facil Greutate: 78kg; Dimensiuni: 730x556x610mm	582
6426390839329	<b>SC-5000E TOP</b> - idem SC-5000, <b>demaraj electric, acumulator inclus</b> 	661
6426390839343	<b>SC-6000 TOP</b> Putere max. 5,5kW , 230V-50Hz , Motor benzina 13 cp Rezervor carburant 25L Autonomie 13,5 ore - 1/2incarcare consum Contor ore/voltmetru/frecventa Senzor lipsa ulei cu led rosu si oprire motor Roti si manere pentru un transport facil Greutate: 81kg; Dimensiuni: 730x556x610mm	604
6426390839367	<b>SC-6000E TOP</b> - idem SC-6000, <b>demaraj electric, acumulator inclus</b> 	684
BT0004370	Ulei motor pe benzina, Italia Star 10W-40 fabricat in Romania, bidon 1L	5,4



6426390839428 **SC-8000E TOP** Putere max. 7kW, 230V-50Hz - Motor benzina 14 cp 718



Rezervor carburant 25L; Autonomie 12,5 ore - 1/2 incarcare consum  
**Contor ore/voltmetru/frecventa, demaraj electric** (acumulator inclus)  
 Senzor lipsa ulei cu led rosu si oprire motor  
 Roti si manere pentru transport incluse  
 Greutate: 88kg; Dimensiuni: 730x556x610mm



6426390839435 **SC-8000TE TOP** Putere max. 7 kW-400V / 2.3kW-230V - Motor benzina 14cp 781



Rezervor carburant 25L; Autonomie 12,5 ore - 1/2 incarcare consum  
**Contor ore/voltmetru/frecventa, demaraj electric** (acumulator inclus)  
 Senzor lipsa ulei cu led rosu si oprire motor  
 Roti si manere pentru transport incluse  
 Greutate: 88kg; Dimensiuni: 730x556x610mm



6426390839022 **SC-10000E TOP** Putere max. 8,5kW , 230V-50Hz - Motor benzina 16 cp 800



Rezervor carburant 25L; Autonomie 12,5 ore - 1/2 incarcare consum  
**Contor ore/voltmetru/frecventa, demaraj electric** (acumulator inclus)  
 Senzor lipsa ulei cu led rosu si oprire motor  
 Roti si manere pentru transport incluse  
 Greutate: 94kg; Dimensiuni: 730x556x610mm



6426390839046 **SC-10000TE TOP** Putere max.8,5kW-400V sau 2,8kW-230V - Motor 16 cp 863



Rezervor carburant 25L; Autonomie 12,5 ore - 1/2 incarcare consum  
**Contor ore/voltmetru/frecventa, demaraj electric** (acumulator inclus)  
 Senzor lipsa ulei cu led rosu si oprire motor  
 Roti si manere pentru transport incluse  
 Greutate: 94kg; Dimensiuni: 730x556x610mm



6426390839404 **SC-8000-ATS TOP** Putere max. 7 kW, 230V-50Hz, Motor benzina 14 cp 846



Rezervor carburant 25L; Autonomie 13 ore - 1/2 incarcare/consum  
**ATS si AVR inclus**, contor ore/voltmetru/frecventa  
 Senzor lipsa ulei cu led rosu si oprire motor  
 Greutate: 88kg; Dimensiuni: 730x556x610mm



6426390839039 **SC-10000E-ATS TOP** Putere max. 8,5kW, 230V-50Hz - Motor benzina 16 cp 928



Rezervor carburant 25L; Autonomie 12,5 ore - 1/2 incarcare consum  
**ATS si AVR inclus** Contor ore/voltmetru/frecventa, demaraj electric  
 Senzor lipsa ulei cu led rosu si oprire motor  
 Roti si manere pentru transport incluse  
 Greutate: 94kg; Dimensiuni: 730x556x610mm



SC1008604	<b>SC-13000-EVO</b> Putere max. 11kW, 230V-50Hz Motor benzina 20 cp Rezervor carburant 45L; Autonomie 13 ore - 1/2 incarcare/consum <b>AVR inclus</b> , conectivitate ATS, contor ore/voltmetru/frecventa Roti si baterie incluse; Senzor lipsa ulei cu led rosu si oprire motor Greutate: 170 kg; Dimensiuni: 730x770x915mm	2.160	
6426390839091	<b>SC-13000-EVO-ATS</b> , idem SC-13000-EVO, <b>ATS inclus</b>	2.187	
SC1008603	<b>SC-13000TEQ-EVO</b> , idem SC-13000-EVO Putere max. 11kW, 400V si 230V - 50Hz	2.070	
6426390839138	<b>SC-13000TEQ-EVO-ATS</b> , idem SC-13000TEQ-EVO, <b>ATS inclus</b>	2.475	
SC1008601	Panou ATS 13000 230V	327	
SC1008599	Panou ATS 13000TEQ 400V si 230V	327	
SC1008602	<b>SC-15000-EVO</b> Putere max. 13kW - 230V-50Hz Motor benzina 22 cp Rezervor carburant 45L; Autonomie 13 ore - 1/2 incarcare consum <b>AVR inclus</b> , conectivitate ATS, contor ore/voltmetru/frecventa Roti si baterie incluse; Senzor lipsa ulei cu led rosu si oprire motor Greutate: 190 kg; Dimensiuni: 770x770x935 mm	2.599	
6426390839145	<b>SC-15000EVO-ATS</b> , idem SC-15000-EVO, <b>ATS inclus</b>	2.792	
SC1008600	<b>SC-15000TE-EVO</b> idem SC-15000-EVO, Putere max. 13 kW, 16 kVA - 400V	2.675	
6426390839152	<b>SC-15000TE-EVO-ATS</b> idem SC-15000TE-EVO, <b>ATS inclus</b>	2.909	
SC1008601	Panou ATS 15000 230V	327	
SC1008599	Panou ATS 15000TE 400V	327	
SC1008598	<b>SC-18000-EVO</b> , Putere max. 17 kW - 230V - 50Hz Motor benzina 33 cp Rezervor carburant 45L; Autonomie 10 ore - 1/2 incarcare consum <b>AVR inclus</b> , conectivitate ATS, contor ore/voltmetru/frecventa Roti si baterie incluse; Senzor lipsa ulei cu led rosu si oprire motor Greutate: 230 kg; Dimensiuni: 900x790x985 mm	3.850	
6426390839169	<b>SC-18000-EVO-ATS</b> , idem SC-18000-EVO, <b>ATS inclus</b>	3.983	
SC1008596	<b>SC-18000TE-EVO</b> , idem SC-18000-EVO, Putere max. 17 kW, 21 kVA - 400V	3.865	
6426390839176	<b>SC-18000TE-EVO-ATS</b> , idem SC-18000TE-EVO, <b>ATS inclus</b>	4.100	
SC1008597	Panou ATS 18000 230V	327	
SC1008595	Panou ATS 18000TE 400V	327	

Cod produs	Descriere produs	Pret Euro (fara TVA)	
SC1009406	<b>SC-1400i</b> Putere max. <b>1,2 kW, 230V-50Hz</b> , Motor Senci SH60B 60cc Rezervor carburant 2L <b>tehnologie alternator tip INVERTER- SENCi</b> Sensor lipsa ulei cu led rosu si oprire motor, insonorizat doar 59 dB Autonomie 50%-100% sarcina 4,5/2,5 ore Greutate: 12kg; Dimensiuni: 430x252x400mm	261	
6426390839190	 <b>SC-2000is</b> Putere max. <b>1,8 kW, 230V-50Hz</b> , Motor benzina Senci SC80 79cc Rezervor carburant 4L <b>tehnologie alternator tip INVERTER- SENCi</b> Sensor lipsa ulei cu led rosu si oprire motor, insonorizat doar 60 dB Autonomie 6,8 ore - 1/2 incarcare consum Greutate: 22kg; Dimensiuni: 540x330x505mm	504	
6426390839183	 <b>SC-2000i</b> Putere max. <b>1,8 kW, 230V-50Hz</b> , Motor benzina <b>YAMAHA</b> 79cc Rezervor carburant 4L <b>tehnologie alternator tip INVERTER- SENCi</b> Sensor lipsa ulei cu led rosu si oprire motor, insonorizat doar 50dB Autonomie 6,8 ore - 1/2 incarcare consum Greutate: 20kg; Dimensiuni: 540x330x505mm	763	
6426390839886	 <b>SC-4000iE-O</b> Putere max. <b>3,8 kW, 230V</b> , motor benzina Senci 223cc Rezervor carburant 10 l <b>tehnologie alternator tip INVERTER- SENCi</b> Sensor lipsa ulei cu led rosu si oprire motor, insonorizat doar 58dB Autonomie 8ore - 1/2 incarcare consum Greutate: 51kg; Dimensiuni: 605x488x560 mm <b>2 telecomenzi</b> - utilizare la 50m spatii deschise si la 15m in spatii cu obstacole	820	
6426390839299	<b>SC-4000i</b> Putere max. <b>4 kW, 230V</b> , motor benzina Senci 223cc Rezervor carburant 13,2 l <b>tehnologie alternator tip INVERTER- SENCi</b> Sensor lipsa ulei cu led rosu si oprire motor, insonorizat doar 58dB Autonomie 13,4ore - 1/2 incarcare consum Greutate: 57kg; Dimensiuni: 690x460x500 mm	811	
SC1009407	<b>SC-5500i</b> Putere max. <b>6 kW, 230V-50Hz</b> , Motor Senci SV320B 320cc Rezervor carburant 13,5L <b>tehnologie alternator tip INVERTER- SENCi</b> Sensor lipsa ulei cu led rosu si oprire motor, insonorizat doar 64dB Autonomie 50%-100% sarcina 11/4,5 ore. Optiune adaugare ATS Greutate: 57,5kg; Dimensiuni: 630x480x540mm <b>2 telecomenzi</b> - utilizare la 50m spatii deschise si la 15m in spatii cu obstacole	947	
SC1009408	<b>SC-8000i</b> Putere max. <b>7,5 kW, 230V-50Hz</b> , Motor Senci SC460 459cc Rezervor carburant 26L <b>tehnologie alternator tip INVERTER- SENCi</b> Sensor lipsa ulei cu led rosu si oprire motor, insonorizat doar 67dB Autonomie 50%-100% sarcina 11/6 ore. Optiune adaugare ATS Greutate: 115kg; Dimensiuni: 820x640x780mm <b>2 telecomenzi</b> - utilizare la 50m spatii deschise si la 15m in spatii cu obstacole	1.786	
SC1009409	<b>SC-15000i</b> Putere max. <b>13 kW, 230V-50Hz</b> , Motor Senci SV750 744cc Rezervor carburant 40L <b>tehnologie alternator tip INVERTER- SENCi</b> Sensor lipsa ulei cu led rosu si oprire motor, insonorizat doar 75dB Autonomie 50%-100% sarcina 11/5 ore. Optiune adaugare ATS Greutate: 170kg; Dimensiuni: 972x783x873mm	4.070	
BT0004370	Ulei pentru motor pe benzina, Italia Star 10W40 fabricat in Romania	5,4	

## Generatoare tip inverter - OPEN

6426390839008 **SC-3200iFE Putere max. 3,2 kW, 230V, motor benzina Senci 208cc** 393

**AVR** Rezervor carburant 15 l **tehnologie alternator tip INVERTER- SENC I**  
Autonomie 12 ore - 1/2 incarcare consum  
Greutate 34 kg; Dimensiuni: 565x442x468 mm



6426390839015 **SC-4200iFE Putere max. 4,2 kW, 230V, motor benzina Senci 223cc** 547

**AVR** Rezervor carburant 15 l **tehnologie alternator tip INVERTER- SENC I**  
Autonomie 11 ore - 1/2 incarcare consum  
Greutate 42 kg; Dimensiuni 557x464x478



## Generator diesel open

6426390839411 **SC-8000DE Generator diesel open** 1.026

Putere max. 7 kW, 230V-50Hz  
Motor diesel, demaraj electric, rezervor combustibil 18 l  
Set roti si manere incluse pentru transport  
Greutate: 117 kg; Dimensiuni LxIxh (mm) 795x540x625 mm



## Generatoare pentru curent si sudura

6426390839206 **SC-200A Generator pentru curent si sudura** 1.156

**AVR** Putere max. 5,5 kW, 230V / 50 Hz  
Motor benzina, demaraj electric, rezervor carburant 18 l  
Amperaj sudura 50 - 200 A; Tip electrod 1,6 - 5 mm  
**AVR inclus**, contor ore/voltmetru/frecventa. Senzor lipsa ulei cu led rosu si oprire motor; Set roti si manere incluse pentru transport;  
Greutate: 99 kg; Dimensiuni: 780x545x632mm



SC1009326 **SC-300 Generator pentru curent si sudura** 2.505

**AVR** Putere max. 3,5 kW, 230V / 50 Hz  
Motor benzina, demaraj electric, rezervor carburant 18 l  
Amperaj sudura 50 - 300 A; Tip electrod 1,6 - 6 mm  
**AVR inclus**, contor ore/voltmetru/frecventa. Senzor lipsa ulei cu led rosu si oprire motor; Set roti si manere incluse pentru transport;  
Greutate: 130 kg; Dimensiuni: 895x554x585mm



SC1009327 **SC-300XL Generator pentru curent si sudura** 2.711

**AVR** Putere max. 3,5 kW, 230V / 50 Hz  
Motor benzina, demaraj electric, rezervor carburant 45 l  
Amperaj sudura 50 - 300 A; Tip electrod 1,6 - 6 mm  
**AVR inclus**, contor ore/voltmetru/frecventa. Senzor lipsa ulei cu led rosu si oprire motor; Set roti si manere incluse pentru transport;  
Greutate: 150 kg; Dimensiuni: 730x600x975mm



BT0004370 Ulei pentru motor pe benzina, Italia Star 10W40 fabricat in Romania



5,4

Cod produs

Descriere produs

Pret Euro (fara TVA)

6426390839398

**SC-7500Q** Generator insonorizat diesel - **ATS si AVR inclus**

1.181



Putere max. 6 kW, 230V-50Hz, demaraj electric, rezervor 18 l  
Greutate: 170 kg; Dimensiuni: Lxlxh 960x560x770 mm



3161304182322

**SC-7500Q-3** Generator insonorizat diesel trifazat - **ATS si AVR inclus**

1.365



Putere max. 400V: 6 kVA / 4,8 kW, Putere max. 230V: 1,6 kW, Putere in regim continuu: 5 kVA / 4 kW, demaraj electric, rezervor 18 l  
Greutate: 164 kg; Dimensiuni: Lxlxh 960x560x770 mm



SC1009324

**SC-10000Q** Generator insonorizat diesel - **ATS si AVR inclus**

1.705



Putere max. 8 kW  
Putere in regim continuu 7,5 kW  
230V-50Hz  
Demaraj electric, rezervor 18 l  
Greutate: 185 kg; Dimensiuni: Lxlxh 1.045x565x815 mm



SC1009325

**SC-10000Q-3** Generator insonorizat diesel trifazat - **ATS si AVR inclus**

1.740



Putere max. / in regim continuu 400V: 8 kW / 7,5 kW  
Putere max. / in regim continuu 230V: 2,7 kW / 2,5 kW  
Demaraj electric, rezervor 18 l  
Greutate: 185 kg; Dimensiuni: Lxlxh 1.045x565x815 mm



Interior captusit cu burete fonoabsorbant din spuma poliuretantica flexibila pentru o izolare fonica sporita

SC1009398

**SCD13000Q-ATS** Generator insonorizat diesel - **ATS si AVR inclus**

3.088



Putere max. 11 kVA  
Putere in regim continuu 10 kVA  
230V-50Hz  
Demaraj electric, rezervor 26 l  
Greutate: 250 kg; Dimensiuni: Lxlxh 1.045x565x815 mm



SC1009399

**SCD13000Q-3-ATS** Generator insonorizat diesel trifazat - **ATS si AVR inclus**

3.075



Putere max. / in regim continuu 400V: 11 kVA  
Putere max. / in regim continuu 230V: 11 kVA  
Demaraj electric, rezervor 26 l  
Greutate: 250 kg; Dimensiuni: Lxlxh 1.045x565x815 mm





**NOU!**

Toate generatoarele sunt configurate standard cu controller DC5x-4G de ultima generatie cu:

- Modul de comunicatii la distanta GPRS, inclusiv GPS
- Protectie cu parola maxim 40 de caractere
- Rata de comunicare CAN pana la 500 Kbps
- Configurabil inclusiv pentru pornire de la distanta si plan de lucru orar/zilnic/lunar.



**Toate generatoarele din gama SCDE includ panou ATS**

SC1009380 **SCDE 19i-YS** Generator insonorizat diesel - **ATS si AVR inclus** 5.536



Putere max. **19 kVA**, 400V - 50 Hz, demaraj electric, rezervor 80 l  
Greutate: 650 kg; Dimensiuni: Lxlxh 1.950x900x1.050 mm



SC1007701 **SCDE 19YSM** Generator insonorizat diesel - **ATS si AVR inclus** 5.526



Putere max. **19 kVA**, 230V - 50 Hz, demaraj electric, rezervor 80 l  
Greutate: 650 kg; Dimensiuni: Lxlxh 1.950x900x1.050 mm

SC1009382 **SCDEi-55i-S** Generator insonorizat diesel - **ATS si AVR inclus** 8.392



Putere max. **55 kVA**, 400V - 50 Hz, demaraj electric, rezervor 100 l  
Greutate: 1.030 kg; Dimensiuni: Lxlxh 2.250x1.000x1.250 mm



SC1009405 **SCDE 72i-YS** Generator insonorizat diesel - **ATS si AVR inclus** 10.268



Putere max. **72 kVA**, 400V - 50 Hz, demaraj electric, rezervor 130 l  
Greutate: 1.194 kg; Dimensiuni: Lxlxh 2.400x1.000x1.250 mm

SC1009383 **SCDE 97i-YS** Generator insonorizat diesel - **ATS si AVR inclus** 12.697



Putere max. **97 kVA**, 400V - 50 Hz, demaraj electric, rezervor 140 l  
Greutate: 1.400 kg; Dimensiuni: Lxlxh 2.400x1.000x1.250 mm



SC1009400 **SCDE 125i-YCS** Generator insonorizat diesel; **ATS si AVR inclus** 15.677



Putere max. **125 kVA**, 400V, demaraj electric, rezervor 340 l  
Greutate: 1.600 kg; Dimensiuni: Lxlxh 3.000x1.100x1.160 mm



SC1009401 **SCDE 162i-YCS** Generator insonorizat diesel; **ATS si AVR inclus** 19.482



Putere max. **162 kVA**, 400V, demaraj electric, rezervor 340 l  
Greutate: 2.100 kg; Dimensiuni: Lxlxh 3.300x1.300x1.820 mm



SC1009402 **SCDE 187i-YCS** Generator insonorizat diesel; **ATS si AVR inclus** 20.133



Putere max. **190 kVA**, 400V, demaraj electric, rezervor 420 l  
Greutate: 2.300 kg; Dimensiuni: Lxlxh 3.300x1.300x1.820 mm



SC1009384 **SCDE 250i-YCS** Generator insonorizat diesel; **ATS si AVR inclus** 23.481



Putere max. **250 kVA**, 400V, demaraj electric, rezervor 420 l  
Greutate: 2.750 kg; Dimensiuni: Lxlxh 4.000x1.800x2.150 mm

SC1009403 **SCDE 312i-YCS** Generator insonorizat diesel; **ATS si AVR inclus** 27.184







Putere max. **312 kVA**, 400V, demaraj electric, rezervor 500 l  
Greutate: 3.000 kg; Dimensiuni: Lxlxh 4.000x1.800x2.150 mm



Cod produs	Descriere produs	Pret Euro (fara TVA)
6426390839527	<b>SCWP-25 Motopompa pentru ape curate</b> cu diam. 1" - 25mm Motor 3 cp-98CC, Rezervor carburant 1,6L Debit: 6m <sup>3</sup> /ora - 100L/min Adancime 8m - distanta de refulare 18m Senzor lipsa ulei cu led rosu si oprire motor Greutate: 16kg; Dimensiuni: 420x350x375mm	135
6426390839534	<b>SCWP-50 Motopompa pentru ape curate</b> cu diam. 2" - 50mm Motor 7 cp-208CC, Rezervor carburant 3,6L Debit: 30m <sup>3</sup> /ora - 500L/min Senzor lipsa ulei cu led rosu si oprire motor Greutate: 26kg; Dimensiuni: 490x405x400mm	153
6426390839541	<b>SCWP-80 Motopompa pentru ape curate</b> cu diam. 3" - 80mm Motor 7,5 cp-223CC, Rezervor carburant 3,6L Debit: 60m <sup>3</sup> /ora - 1.000L/min Adancime 8m - distanta de refulare 30m Senzor lipsa ulei cu led rosu si oprire motor Greutate: 28,5kg; Dimensiuni: 520x405x415mm	170
6426390839558	<b>SCWP-80E Motopompa pentru ape curate</b> cu diam. 3" - 80mm Motor 7,5 cp-223CC, Rezervor carburant 11,3L, demaraj electric Debit: 60m <sup>3</sup> /ora - 1.000L/min Adancime 8m - distanta de refulare 30m Senzor lipsa ulei cu led rosu si oprire motor Greutate: 28,5kg; Dimensiuni: 520x405x415mm	294
6426390839510	<b>SCWP-100A Motopompa pentru ape curate</b> cu diam. 4" - 100mm Motor 7,5 cp-223CC, Rezervor carburant 3,6L Debit: 80m <sup>3</sup> /ora - 1.330L/min Adancime 8m - distanta de refulare 25m Senzor lipsa ulei cu led rosu si oprire motor Greutate: 40kg; Dimensiuni: 680x465x545mm	217
6426390839572	<b>SCWT-80 Motopompa pentru ape murdare</b> cu diam. 3" - 80mm Motor 7,5 cp-223CC, Rezervor carburant 3,6L Debit: 65m <sup>3</sup> /ora - 1.100L/min Adancime 8m - distanta de refulare 28m Senzor lipsa ulei cu led rosu si oprire motor Greutate: 38kg; Dimensiuni: 580x450x440mm	249
6426390839589	<b>SCWT-80E Motopompa pentru ape murdare</b> cu diam. 3" - 80mm Motor 7,5 cp-223CC, Rezervor carburant 3,6L, demaraj electric Debit: 65m <sup>3</sup> /ora - 1.100L/min Adancime 8m - distanta de refulare 28m Senzor lipsa ulei cu led rosu si oprire motor Greutate: 38kg; Dimensiuni: 580x450x440mm	340
6426390839565	<b>SCWT-100 Motopompa pentru ape murdare</b> cu diam. 4" - 100mm Motor 13 cp Rezervor carburant 6,5L Debit: 99m <sup>3</sup> /ora - 1.650L/min Adancime 8m - distanta de refulare 28m Senzor lipsa ulei cu led rosu si oprire motor Greutate: 42kg; Dimensiuni: 580x480x470mm	390
6426390839503	<b>SCPW-2700 Echipament pentru spalat cu presiune - 7,9 l/min.</b> Motor Senci 6,5 cp, rezervor combustibil 3,5 l Debit apa: 7,9 l/min. presiune de lucru 165 bar Greutate: 28 kg; Dimensiuni 590x540x595 mm	365





Cod produs	Descriere produs	Pret Euro (fara TVA)	
<b>Pompe electrice pentru drenaj ape reziduale - SERIA PONSTAR</b>			
4971770430860	<b>Pompa submersibila KOSHIN PXL-52522-BAC</b> motor electric 220V 540W Ø 25 mm debit 7.2 mc/h, granulometrie 6 mm	230	
	<b>(Nou!)</b>		
4971770430839	<b>Pompa submersibila KOSHIN PX-55022-BAC</b> motor electric 220V, 620W Ø 50 mm debit 15.5 mc/h, granulometrie 6 mm	208	
	<b>(Nou!)</b>		
<b>Pompe electrice pentru drenaj ape reziduale - SERIA DEWATERING</b>			
4971770770010	<b>Pompa submersibila KOSHIN PXJ-150-BAB</b> motor electric 220V/150W Ø 15-20-25 mm debit 5.7 mc/h, granulometrie 1 mm	123	
	<b>(Nou!)</b>		
4971770770027	<b>Pompa submersibila KOSHIN PXJ-250-BAB</b> motor electric 220V 250W, Ø 40 mm debit 11.4 mc/h, granulometrie 6 mm, corp pompa inox	241	
	<b>(Nou!)</b>		
KSPXJ-400-BAB	<b>Pompa submersibila KOSHIN PXJ-400-BAB</b> motor electric 220V 400W Ø 50 mm debit 11.7 mc/h, granulometrie 6 mm, corp pompa inox	262	
	<b>(Nou!)</b>		
4971770770041	<b>Pompa submersibila KOSHIN PXJ-750-BAB</b> motor electric 220V 750W Ø 50 mm debit 19.5 mc/h, granulometrie 6 mm, corp pompa inox	466	
	<b>(Nou!)</b>		
<b>Pompe electrice pentru ape murdare - SERIA VORTEX</b> <b>*includ Impeller (roata centrifugala cu palete)</b>			
4971770770058	<b>Pompa submersibila Vortex KOSHIN PKJ-150-BAB</b> motor electric 220V, 150W Ø 32 mm debit 9 mc/h, granulometrie pana la 10 mm	140	
	<b>(Nou!)</b>		
4971770770065	<b>Pompa submersibila Vortex KOSHIN PKJ-250-BAB</b> motor electric 220V 250W, Ø 40 mm debit 13.5 mc/h, granulometrie pana la 30 mm	214	
	<b>(Nou!)</b>		
4971770770072	<b>Pompa submersibila Vortex KOSHIN PKJ-400-BAB</b> motor electric 220V 400W Ø 50 mm debit 14.7 mc/h, granulometrie pana la 30 mm	241	
	<b>(Nou!)</b>		
4971770770089	<b>Pompa submersibila Vortex KOSHIN PKJ-750-BAB</b> motor electric 220V 750W Ø 50 mm debit 20.4 mc/h, granulometrie pana la 30 mm	447	
	<b>(Nou!)</b>		
4971770770096	<b>Pompa submersibila Vortex KOSHIN PKJ-1500-BAB</b> motor electric 220V 1500W Ø 80 mm debit 40.8 mc/h, granulometrie pana la 30 mm	668	
	<b>(Nou!)</b>		
<b>Pompe electrice cu tocator pentru deseuri organice - SERIA GRINDER</b>			
4971770770102	<b>Pompa submersibila Grinder KOSHIN PKG-750-BAB</b> motor electric 220V 750W Ø 32 mm debit 10.5 mc/h	651	
	<b>(Nou!)</b>		
4971770770119	<b>Pompa submersibila Grinder KOSHIN PKG-1200-BAB</b> motor electric 220V 1200W Ø 32 mm debit 10.8 mc/h	744	
	<b>(Nou!)</b>		
4971770770126	<b>Pompa submersibila Grinder KOSHIN PKG-1500-BAB</b> motor electric 220V 1500W Ø 32 mm debit 10.8 mc/h	931	
	<b>(Nou!)</b>		

Cod produs	Descriere produs	Pret Euro (fara TVA)
<b>Motopompe ape curate - seria SEV</b>		
4971770126190	<b>Motopompa ape curate KOSHIN SEV-25L-BAC</b> motor Koshin KC26 Ø 25 mm debit 6.6 mc/h	187
	<b>Nou!</b>	
4971770127074	<b>Motopompa ape curate KOSHIN SEV-25F-BAB</b> motor Koshin KC35 Ø 25 mm debit 8 mc/h	240
	<b>Nou!</b>	
4971770125988	<b>Motopompa ape curate KOSHIN SEV-50X-BAE</b> motor Koshin K180 Ø 50 mm debit 37 mc/h	245
	<b>Nou!</b>	
4971770126022	<b>Motopompa ape curate KOSHIN SEV-80X-BAC</b> motor Koshin K180 Ø 80 mm debit 63 mc/h	275
	<b>Nou!</b>	
4971770129764	<b>Motopompa ape curate KOSHIN SEV-100X-BAE</b> motor Koshin K300 Ø 100 mm debit 90 mc/h	719
	<b>Nou!</b>	
<b>Motopompe ape semimurdare - seria STV</b>		
4971770126213	<b>Motopompa ape semimurdare KOSHIN STV-50X-BAA</b> motor Koshin K180 Ø 50 mm debit 34 mc/h	322
	<b>Nou!</b>	
4971770126220	<b>Motopompa ape semimurdare KOSHIN STV-80X-BAA</b> motor Koshin K180 Ø 80 mm debit 54 mc/h	355
	<b>Nou!</b>	
4971770129771	<b>Motopompa ape semimurdare KOSHIN STV-100X-BAE</b> motor Koshin K300 Ø 100 mm debit 90 mc/h	830
	<b>Nou!</b>	
<b>Motopompe ape foarte murdare - seria KTZ</b>		
4971770129788	<b>Motopompa ape foarte murdare KOSHIN KTZ-50X-BAE</b> motor Koshin K180 Ø 50 mm debit 41 mc/h	624
	<b>Nou!</b>	
4971770129795	<b>Motopompa ape foarte murdare KOSHIN KTZ-80X-BAE</b> motor Koshin K300 Ø 80 mm debit 82 mc/h	835
	<b>Nou!</b>	
4971770129801	<b>Motopompa ape foarte murdare KOSHIN KTZ-100X-BAE</b> motor Koshin K420 Ø 100 mm debit 101 mc/h	1.287
	<b>Nou!</b>	

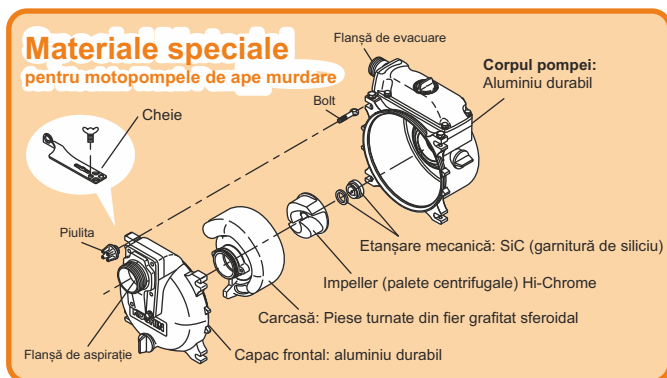

Cod produs	Descriere produs	Pret Euro (fara TVA)
<b>Motopompe ape curate - seria SEH</b>		
4971770123519	<b>Motopompa ape curate KOSHIN SEH-25H-BAD</b> motor Honda GXH50 Ø 25 mm debit 8.1 mc/h	336
4971770123328	<b>Motopompa ape curate KOSHIN SEH-25L-BAA</b> motor Honda GX25 Ø 25 mm debit 6.9 mc/h	255
4971770111011	<b>Motopompa ape curate KOSHIN SEH-50X-BBB</b> , motor Honda GX120, Ø 50 mm, debit 38 mc/h	367
4971770111004	<b>Motopompa ape curate KOSHIN SEH-80X-BAS</b> motor Honda GX160 Ø 80 mm debit 66 mc/h	408
4971770121768	<b>Motopompa ape curate KOSHIN SEH-100X-BAE</b> motor Honda GX240 Ø 100 mm debit 87 mc/h	893
<b>Motopompe pentru ape semimurdare - seria STH</b>		
4971770113299	<b>Motopompa ape semimurdare KOSHIN STH-50X-BCO</b> motor Honda GX120 Ø 50 mm debit 36 mc/h	416
4971770123625	<b>Motopompa ape semimurdare KOSHIN STH-80X-BDW</b> motor Honda GX160 Ø 80 mm debit 54 mc/h	461
<b>Motopompe pentru ape foarte murdare - seria KTH</b>		
4971770120693	<b>Motopompa ape foarte murdare KOSHIN KTH-50X-BAB</b> motor Honda GX160 Ø 50 mm debit 42 mc/h	714
4971770120709	<b>Motopompa ape foarte murdare KOSHIN KTH-80X-BAB</b> motor Honda GX240 Ø 80 mm debit 80 mc/h	1.024
4971770122789	<b>Motopompa ape foarte murdare KOSHIN KTH-100X-BAF</b> motor Honda GX340 Ø100 mm debit 99 mc/h	1.456
<b>Motopompe pentru ape sarate si fertilizatori - seria PGH</b>		
4971770130128	<b>Motopompa termoplastica pentru ape sarate si fertilizatori KOSHIN PGH-50-BAG</b> motor Honda GX120 Ø 50 mm debit 33.5 mc/h	451
<b>Motopompe de inalta presiune - seria SERH</b>		
4971770127395	<b>Motopompa de inalta presiune KOSHIN SERH-50V-BAA</b> motor Honda GX160HR Ø 50 mm debit 26 mc/h	627
4971770129177	<b>Motopompa de inalta presiune KOSHIN SERH-50Z-BAA</b> motor Honda GX200HR Ø 50 mm debit 30 mc/h	663



**Priza cu capac**  
 COD: EFFR-P316

Montarea mânerului cu dispozitiv de fixare rapidă  
 Cablu strâns cu inel anti-desuruburi  
 Rezistență bună la temperaturi ridicate și scăzute  
 Aparat de conectare rapidă fără șuruburi Wives

CE RoHS În conformitate cu CEI EN 60309-1-2

IP 44 A 16 2P+T 230V



3,7 €

**Priza cu capac**  
 COD: EFFR-P53267

Montarea mânerului cu dispozitiv de fixare rapidă  
 Cablu strâns cu inel anti-desuruburi  
 Rezistență bună la temperaturi ridicate și scăzute  
 Aparat de conectare rapidă fără șuruburi Wives

CE RoHS În conformitate cu CEI EN 60309-1-2

IP 67 A 32 2P+N 400V



16,8 €

**Adaptor stecher Schuko si priza**  
 COD: EFFR-17024D

CE RoHS În conformitate cu CEI EN 60309-1-2

IP 20 A 16 2P+N 230V



7,9 €

**Adaptor stecher Schuko - cablu**  
 COD: EFFR-17029DE

CE RoHS În conformitate cu CEI EN 60309-1-2

IP 44 A 16 2P+N 230V



12,1 €

**Adaptor stecher 400V cu priza Schuko 230V**  
 COD: EFFR-17025

CE RoHS În conformitate cu CEI EN 60309-1-2

IP 44 A 16 4P+N 400V/230V



15,2 €

**Stecher Schuko**  
 COD: EFFR-S316/DE

Montarea mânerului cu dispozitiv de fixare rapidă  
 Cablu strâns cu inel anti-desuruburi  
 Rezistență bună la temperaturi ridicate și scăzute  
 Aparat de conectare rapidă fără șuruburi Wives

CE RoHS În conformitate cu CEI EN 60309-1-2

IP 44 A 16 2P+T 230V



1,9 €

**Stecher**  
 COD: EFFR-S53267

Montarea mânerului cu dispozitiv de fixare rapidă  
 Cablu strâns cu inel anti-desuruburi  
 Rezistență bună la temperaturi ridicate și scăzute  
 Aparat de conectare rapidă fără șuruburi Wives

CE RoHS În conformitate cu CEI EN 60309-1-2

IP 67 A 32 4P+N 400V



11,3 €

**Stecher de perete cu inversiune de faze**  
 COD: EFFR-S53267P-INV

Montarea mânerului cu dispozitiv de fixare rapidă  
 Cablu strâns cu inel anti-desuruburi  
 Rezistență bună la temperaturi ridicate și scăzute  
 Aparat de conectare rapidă fără șuruburi Wives

CE RoHS În conformitate cu CEI EN 60309-1-2

IP 67 A 32 4P+N 400V



26,6 €

**Intreupator cu doua butoane stop**  
 COD: EFFR-SMM/I

Comutator pentru scule electrice incorporate.  
 Conexiune prin faston.  
 Functie oprire urgenta.  
 Garnitura si suport de fixare.  
 Cu contact de auto-prindere separat și cu punte pentru utilizarea unui tampon termic sau a unui buton de urgență extern.

CE RoHS În conformitate cu CEI EN 60947

IP 55 A 16 230V



9,6 €

**Intreupator cu autoretinere, doua butoane stop**  
 COD: EFFR-SMM/II/AU

Comutator pentru scule electrice incorporate.  
 Conexiune prin faston.  
 Functie oprire urgenta.  
 Garnitura si suport de fixare.  
 Cu contact de auto-prindere separat și cu punte pentru utilizarea unui tampon termic sau a unui buton de urgență extern.

CE RoHS În conformitate cu CEI EN 60947

IP 44 A 16 230V



9,6 €

- Caseta ABS rosie
  - Cablu cauciuc H07RN-F
  - Lungime 3,5m sectiune 2.5mmq
  - Mufa de alimentare CEE, standard IEC 309
  - Suruburi interne, externe si arcuri din oțel inoxidabil
  - Maner de transport
  - Posibilitate de montare pe trepied
  - Posibilitate de fixare pe perete cu console de fixare
- Pentru utilizarea continuă a comutatoarelor, „In” este retrogradat la un „I termic” mai mic de 35%.

IP  
44

A  
16



### Tablou electric echipat cu 4 prize

COD: EFPO-DN0121

#### Caracteristici tehnice:

Putere max.: 8 kW  
Alimentare (tip): mufa CEE 16A 3P + N + T  
IP44  
1 x prize Schuko / 16A  
2 x prize 2P + E 16A  
1 x prize 3P + E 16A

192 €



### Tablou electric echipat cu 4 prize

COD: EFPO-DN1111

#### Caracteristici tehnice:

Putere max.: 8 kW  
Alimentare (tip): mufa CEE 16A 3P + N + T  
IP44  
1 x prize Schuko / 16A  
1 x prize 2P + E 16A  
1 x prize 3P + E 16A  
1 x prize 3P + N + E 16A

196 €

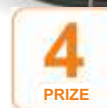

### Tablou electric echipat cu 4 prize

COD: EFPO-DN0022

#### Caracteristici tehnice:

Putere max.: 8 kW  
Alimentare (tip): mufa CEE 16A F + N + T  
IP44  
2 x prize Schuko / 16A  
2 x prize 2P + T 16A

168 €

Panou electric portabil, practic si usor de manevrat. Datorită versatilității, compactității și robusteții, poate fi utilizat în: șantier, service-uri, agricultură, laboratoare precum și în zone unde este necesară rezistența mare la impact, la temperaturi sau substanțe chimice.

Caseta robustă și durabilă, realizată din ABS, cu garnitura de închidere integrată.

Mâner de transport construit împreună cu corpul de panoul și suruburile de închidere din oțel inoxidabil.

Protecție integrată magnetică/reziduală.

Poate fi montat pe un suport sau pe perete cu accesorii adecvate.



IP44



In conformitate cu  
CEI EN 61 439-4



COD: EFPS-DS101010020/35SP  
COD: EFPS-DS101011020/35SP  
Tablourile includ cablu 3,5 m



COD: EFPO-DE001010012G



COD: EFPS-DE101010014GP



3P+N+T  
63 A

3P+N+T  
32 A

3P+N+T  
16 A

3P+T  
16 A

2P+T  
16 A

2P+T  
16 A

Buton  
oprire  
urgenta

Putere max.  
(Kw)

Tip priză

**Tablou electric IP66 echipat cu prize** 1 1 1 0 2 0 DA 35 3P+N+T 63A **643 €**  
COD: EFPS-DS101010020/35SP

**Tablou electric IP66 echipat cu prize** 1 1 1 1 2 0 DA 35 3P+N+T 63A **654 €**  
COD: EFPS-DS101011020/35SP

**Tablou electric IP44 echipat cu prize** 0 1 1 0 1 2 DA 18 4P+T 32A **220 €**  
COD: EFPO-DE001010012G

**Tablou electric IP44 echipat cu prize** 1 1 1 0 1 4 DA 35 4P+T 63A **520 €**  
COD: EFPS-DE101010014GP

## ECHIPAMENTE PENTRU TAIERE GRESIE | FAIANTA

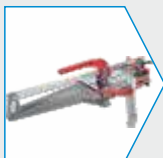

**Masini manuale de taiat gresie | faianta**  
Pagina 111



**Masini electrice de taiat gresie | faianta**  
Pagina 113



**Echipamente diverse pentru taiere/finisare si ventuze ridicare**  
Pagina 114



**Freze, caroate si accesorii**  
Pagina 115



**Discuri diamantate**  
Pagina 116



Cod produs

Descriere produs

Pret Euro (fara TVA)

## MiniMontolit Masina de taiat gresie si faianta, gama economica

8023743000245	<b>MiniMontolit 24</b> Dimensiuni de taiere 220mm, adancime 15mm	40,5
8023743007015	<b>MiniMontolit 26A2</b> Dimensiuni de taiere 360mm, adancime 20mm	81,9
8023743007022	<b>MiniMontolit 43A2</b> Dimensiuni de taiere 450mm, adancime 20mm	115



## MiniPiuma Masina de taiat gresie si faianta, gama profesionala

8023743004083	<b>MiniPiuma 26P</b> Dimensiuni de taiere 360mm, adancime 20mm	150
8023743004120	<b>MiniPiuma 26PB</b> Dimensiuni de taiere 360, adancime 20mm, include geanta plastic	180
8023743004106	<b>MiniPiuma 43P</b> Dimensiuni de taiere 450mm, adancime 20mm	178
8023743004137	<b>MiniPiuma 43PB</b> Dimensiuni de taiere 450, adancime 20mm include geanta plastic	208



## MasterPiuma Masina de taiat gresie si faianta, gama profesionala cu sistem de lubrifiere automat a rotitei de taiere

8023743018059	<b>MasterPiuma 44P3</b> Dimensiuni de taiere 440mm, adancime 22mm	245
8023743018066	<b>MasterPiuma 52P3</b> Dimensiuni de taiere 520mm, adancime 22mm	264
8023743018073	<b>MasterPiuma 63P3</b> Dimensiuni de taiere 630mm, adancime 22mm	293
8023743018080	<b>MasterPiuma 75P3</b> Dimensiuni de taiere 750mm, adancime 22mm	348
8023743018097	<b>MasterPiuma 93P3</b> Dimensiuni de taiere 930mm, adancime 22mm	393
8023743018103	<b>MasterPiuma 125P3</b> Dimensiuni de taiere 1.250mm, adancime 22mm	650
8023743018110	<b>MasterPiuma 155P3</b> Dimensiuni de taiere 1.550mm, adancime 22mm	831



Art. 63P5  
63cm



Art. 75P5  
75cm



Art. 93P5  
93cm



Art. 131P5  
131cm



Art. 161P5  
161cm

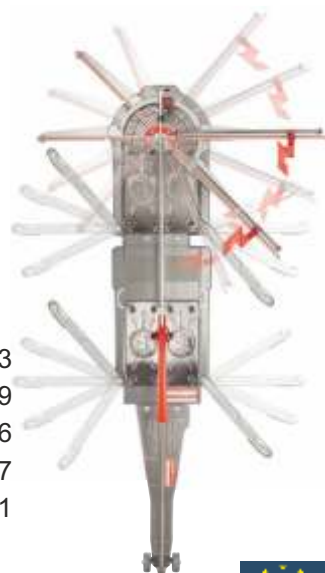

8023743028577	<b>MasterPiuma 63P5-XL</b> Dimensiuni de taiere 630mm, adancime 20mm	333
8023743028584	<b>MasterPiuma 75P5</b> Dimensiuni de taiere 750mm, adancime 20mm	379
8023743028591	<b>MasterPiuma 93P5</b> Dimensiuni de taiere 930mm, adancime 20mm	426
8023743028607	<b>MasterPiuma 131P5</b> Dimensiuni de taiere 1.310mm, adancime 20mm	657
8023743028614	<b>MasterPiuma 161P5</b> Dimensiuni de taiere 1.610mm, adancime 20mm	841

Cod produs

Descriere produs

Pret Euro (fara TVA)

8023743030303 **ATLAS - Suport reglabil pentru placi ceramice mari.** 74,3



**Înălțime reglabilă:** se poate adapta fără probleme la aproape orice masina de taiat gresie/faianta de pe piață.

**Sistem cu arcuri:** Acest sistem permite placii de gresie/faianta să coboare ușor în timpul inciziei.

**Baza anti-alunecare:** Suprafața antialunecare face ca ATLAS sa rămână ferm pe poziție în timpul utilizării.

**Proudly Italian:** 100% proiectat și fabricat în Italia, garantând o calitate de top.

**Ecologic:** Fabricat din plastic ABS reciclabil, ATLAS nu este doar extrem de durabil, ci și responsabil cu mediul înconjurător.



Set 2 buc.



8023743018141 245T Rotita TITAN pentru seriile MINI si MASTER

7,6

8023743006902 Protectie cauciuc pentru taiere mozaic

41,3



8023743017717 Baseboard art.64 Suport pentru directionare placa, pentru seria MASTER

47,2



8023743018202 515-5 Fiola ulei de lubrifiere (set 5 buc.)

7,6

8023743019193 Vertigo Suport pentru taiere verticala, pentru seria MASTER

315



8023743020724 Cover - Husa pentru masinile de taiat Masterpiuma

41,3



8023743017939 Maner 7mm compatibil cu seria P2 - P3 (44 - 63P3)

65

8023743017946 Maner 12mm compatibil cu seria P2 - P3 (75 - 155P3)

69,2



Accesoriu pentru ruperea placii dupa taiere

8023743013733 449P Sistem de rupere a placii, se utilizeaza impreuna cu art. 507 sau 446P

27,8

8023743018264 Accesoriu rupere placa seria P3

16,9

8023743006063 Accesoriu rupere placa pentru seria P2

13,5





Cod produs	Descriere produs	Pret Euro (fara TVA)
8023743020397	<b>F1-131</b> Masina pentru taiat gresie, faianta, motor 2,2 kW Lungime max. 1.310 mm, grosime 0- 50 mm Disc Ø250 mm inclus, coroana sectionata, taiere la 90° si 45° Greutate echipament: 85 kg	2.415
8023743020403	<b>F1-151</b> Masina pentru taiat gresie, faianta, motor 2,2 kW Lungime max. 1.510 mm, grosime 0 - 50 mm Disc Ø250 mm inclus, coroana sectionata, taiere la 90° si 45° Greutate echipament: 100 kg	2.872
8023743020410	<b>F1-181</b> Masina pentru taiat gresie, faianta, motor 2,2 kW Lungime max. 1.810 mm, grosime 0 - 50 mm Disc Ø250 mm inclus, coroana sectionata, taiere la 90° si 45° Greutate echipament: 112 kg	3.458
8023743023343	<b>Top Profile</b> echipament pentru slefuirea marginilor placilor de gresie/faianta fara praf, motor 230V, 800 W, turatie 11.000 rpm, Greutate 4,7 kg	
8023743023374	<b>FPE15TP</b> Disc diamantat R 15 mm, unghi 45°, mediu	
8023743023381	<b>FPE15TPGF</b> Disc diamantat R 15 mm, unghi 45°, fin	
BMFPE03TP	<b>FPE03TP</b> Disc diamantat R 3 mm, unghi 45°	
BMFPE05TP	<b>FPE05TP</b> Disc diamantat R 5 mm, unghi 45°	
8023743023411	<b>FPB03TP</b> Disc diamantat R 3 mm	
8023743023428	<b>FPB05TP</b> Disc diamantat R 5 mm	
8023743023435	<b>FPB10TP</b> Disc diamantat R 10 mm	
8023743027891	<b>Flash Line EVO3</b> - Echipament pentru taierea placilor extra mari Lungime max. 3.400 mm Grosime placa 0 - 10 mm Greutate: 8 kg Echipare standard: 3 segmente x 1.200 mm cu banda silicon anti alunecare + dispozitiv taiere + dispozitiv rupere + husa transport	464
8023743021301	<b>Moto Flash Line</b> - Echipament pentru taierea placilor extra mari Motor electric 1,6 kW, 230V, turatie 5.000 rpm Lungime max. taiere 3.400 mm; Grosime placa 0- 200 mm Disc inclus: TCS150MFL 150 mm, prindere disc 30 / 22,5 mm Echipare standard: 3 segmente x 1.200 mm cu banda silicon anti alunecare + dispozitiv taiere + dispozitiv rupere + husa transport Greutate: 12,8 kg	844
8023743000566	<b>Art. 54</b> Cleste pentru ceramica Montolit 54	25,3
8023743022339	<b>Art. 33W</b> Cleste pentru ceramica Montolit 33W	43,1
8023743023015	<b>Art. 55W2</b> Cleste pentru ceramica Montolit 55W cu role 242TW	35,4
8023743001839	<b>Art. 25V</b> Cutter pentru taiere sticla/ceramica/vitrocaramica Montolit	24,5

Cod produs	Descriere produs	Pret Euro (fara TVA)
8023743021332	<b>300-76 Ventuza</b> pentru ridicare placi de mari dimensiuni Sarcina max.150 kg, diam. exterior 200mm.	160
8023743023060	<b>Battile</b> Ventuza electrica cu vibratii pentru ridicat placi de mari dimensiuni Motor 8,4V, acumulator Li-ion 2,5 Ah 21 Wh Amperaj incarcare 1,5A, timp de reincarcare 2 h Frecventa vibratii 5.000 - 18.000 rpm, greutate 0,95 kg	177
8023743028072	<b>Battile Pro-2B</b> Ventuza electrica cu vibratii, ridicare placi de mari dimensiuni Motor 16V, 2 acumulatori Li-ion 2 Ah 32 Wh Amperaj incarcare 1 A, timp de reincarcare 2,5 h Frecventa vibratii 5.000 - 12.000 rpm, greutate 1,35 kg	295
8023743030426	<b>Gecone</b> - Ventuza electrica cu acumulator Li-Ion 12V 1.5Ah, sarcina max. 200kg, concepută EXCLUSIV pentru ridicarea plăcilor ceramice și porțelanului, sticlei, granitului și marmurei, indiferent de grosime. GECONE vine standard cu trei inele de etanșare interschimbabile pentru suprafețe netede, texturate și 3D. Suprafata contact 300x600mm Greutate: 1,6 kg	305
BM300-80L	<b>Lift 300-80L</b> capacitate ridicare 40 kg, greutate sistem 9,5 kg	533
8023743024128	<b>Super Lift 300-70SL-MOB</b> , capacitate ridicare 80 kg, Greutate sistem 34 kg	1.205
8023743017120	<b>300-20 Masa de lucru</b> pentru placi foarte mari Barele de aluminiu au insertii de cauciuc anti-alunecare Dimensiuni 1.150 x 1.800 mm, greutate 34 kg	670
8023743023497	<b>Blockut - Ghilotina pentru pavele, dale si borduri gama profesionala,</b> <b>forta de rupere 4.100 kg</b> Blockut - Ghilotina Montolit lungime taiere 330 mm, grosime 0 - 110 mm Presiune max. aplicata 4.100 kg, greutate echipament 28 kg	472
8023743000450	<b>Art. 42</b> Ghilotina pentru tigle	238
8023743023503	<b>Art. 208BC</b> Set lame ghilotina Blockut	16
BM0003419	<b>Art. 205</b> Set lame ghilotina Revolver 4	120
BM0003244	<b>Art. 208L</b> Set lame ghilotina Revolver 6L	89
8023743017335	<b>PINZONE</b> Manere pentru borduri/pavele din piatra, granit sau ciment Grosime material intre 5-18 cm Sarcina max.: 200 kg Greutate echipament: 11 kg	257

Cod produs      Descriere produs      Pret Euro (fara TVA)

**Perforari in: gresie portelanata, ceramica, faianta, granit, marmura, mozaic**



- 8023743015317 **FAJ05** Freza pentru ceramica diam. 5mm Montolit
- 8023743015324 **FAJ06** Freza pentru ceramica diam. 6mm Montolit
- 8023743015331 **FAJ08** Freza pentru ceramica diam. 8mm Montolit
- 8023743015348 **FAJ10** Freza pentru ceramica diam. 10mm Montolit
- 8023743015355 **FAJ12** Freza pentru ceramica diam. 12mm Montolit
- 8023743000849 Suport cu prindere in mandrina pentru freza diamantata Montolit

21,9  
19,5  
20,5  
20,5  
25,0  
58,2



**Perforari in: gresie portelanata, ceramica, faianta, granit**



- BM0003874 **FTJ05** Freza diamantata pentru ceramica diam. 5mm Montolit
- BM0003875 **FTJ06** Freza diamantata pentru ceramica diam. 6mm Montolit
- BM0003876 **FTJ08** Freza diamantata pentru ceramica diam. 8mm Montolit
- BM0003877 **FTJ10** Freza diamantata pentru ceramica diam. 10mm Montolit
- BM0003878 **FTJ12** Freza diamantata pentru ceramica diam. 12mm Montolit

35,2  
38,0  
38,3  
40,6  
53,1



**Perforari in: gresie portelanata, ceramica dura, granit, marmura**

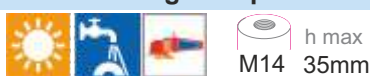

- 8023743013290 **FS16** Carota ceramica/granit/marmura diam. 16mm Montolit
- 8023743003086 **FS20** Carota ceramica/granit/marmura diam. 20mm Montolit
- 8023743013313 **FS30** Carota ceramica/granit/marmura diam. 30mm Montolit
- 8023743006483 **FS40** Carota ceramica/granit/marmura diam. 40mm Montolit
- 8023743000801 **FS50** Carota ceramica/granit/marmura diam. 50mm Montolit
- 8023743013504 **FS68** Carota ceramica/granit/marmura diam. 68mm Montolit
- 8023743019629 Art. AUFS Adaptor pentru conectare cu masina de gaurit

51  
61  
73,4  
90  
114  
134,4  
16,03



**Perforari in: gresie portelanata, ceramica, faianta, granit, marmura**



- BM0003885 **FA20** Carota-umed ceramica/granit/marmura diam. 20mm Montolit
- BM0003886 **FA30** Carota-umed ceramica/granit/marmura diam. 30mm Montolit
- BM0003887 **FA35** Carota-umed ceramica/granit/marmura diam. 35mm Montolit
- BM0003888 **FA40** Carota-umed ceramica/granit/marmura diam. 40mm Montolit
- BM0003889 **FA50** Carota-umed ceramica/granit/marmura diam. 50mm Montolit
- BM0003890 **FA60** Carota-umed ceramica/granit/marmura diam. 60mm Montolit
- BM0003891 **FA70** Carota-umed ceramica/granit/marmura diam. 70mm Montolit
- BM0003892 **FA75** Carota-umed ceramica/granit/marmura diam. 75mm Montolit
- 8023743008289 **FA100** Carota-umed ceramica/granit/marmura diam. 100mm Montolit
- 8023743021257 Art. AUFA Adaptor pentru conectarea cu masina de gaurit

66,4  
68,8  
70,3  
73,4  
80  
97  
105  
110  
141  
16



- 8023743019780 **M-Performer** Pasta pentru racirea frezelor, creste durata de viata a frezei si viteza de lucru



13,5



Cod produs	Descriere produs	Pret Euro (fara TVA)
<b>Disc taiere gresie portelanata, ceramica Pro, granit</b>		
8023743011975	<b>SCX200</b> Disc 200 mm, grosime 2 mm, prindere 25,4 / 22,2 mm	114
8023743011982	<b>SCX250</b> Disc 250 mm, grosime 2,2 mm, prindere 30 / 25,4 mm	150
8023743012149	<b>SCX300</b> Disc 300 mm, grosime 2,4 mm, prindere 30 / 25,4 mm	171
8023743012149	<b>SCX350</b> Disc 350 mm, grosime 2,4 mm, prindere 30 / 25,4 mm	223
	<b>SCX400</b> Disc 400 mm, grosime 3,2 mm, prindere 60 / 50 mm	
<b>Disc SCXS-T coroana continua pentru gresie portelanata, ultragroase, ceramica si granit</b>		
8023743021394	<b>SCXS-T 200</b> Ø 200 mm, grosime 2 mm, prindere 30/25,4 mm	141
8023743021400	<b>SCXS-T 250</b> Ø 250 mm, grosime 2,2 mm, prindere 30/25,4 mm	178
8023743021417	<b>SCXS-T 300</b> Ø 300 mm, grosime 2,4 mm, prindere 30/25,4 mm	200
8023743021424	<b>SCXS-T 350</b> Ø 350 mm, grosime 2,4 mm, prindere 30/25,4 mm	259
<b>Disc CGX pentru gresie portelanata/ceramica dura</b>		
8023743021455	<b>CGX115</b> Ø115 mm, grosime 1,3 mm, prindere 22,2 mm	45,2
8023743021462	<b>CGX125</b> Ø 125 mm, grosime 1,3 mm, prindere 22,2 mm	50,0
<b>Disc CX coroana continua, pentru gresie portelanata, ceramica delicata, marmura si granit</b>		
8023743020328	<b>CX 250</b> Ø 250 mm, grosime 2 mm, prindere 30/25,4 mm	118
8023743020335	<b>CX 300</b> Ø 300 mm, grosime 2,2 mm, prindere 30/25,4 mm	137
8023743020342	<b>CX 350</b> Ø 350 mm, grosime 2,2 mm, prindere 30/25,4 mm	180
<b>Disc taiere gresie portelanata, ceramica dura</b>		
8023743014877	<b>CG115</b> Ø 115 mm, 22,2 mm	43
8023743014884	<b>CG125</b> Ø 22,2 mm	47
<b>Disc taiere mozaic, piatra naturala, ceramica fina si moale</b>		
8023743006506	<b>CM100</b> Disc 100 mm, grosime 1,2 mm, prindere 22,2 mm	37,5
8023743006513	<b>CM115</b> Disc 115 mm, grosime 1,2 mm, prindere 22,2 mm	40,5
8023743006520	<b>CM125</b> Disc 125 mm, grosime 1,2 mm, prindere 22,2 mm	42
<b>Disc taiere gresie portelanata, ceramica dura</b>		
8023743015263	<b>TCS85</b> Disc Red Line 85 mm, grosime 1 mm, prindere 22,2 mm	26,6
<b>Disc Perfetto coroana sectionata pentru gresie portelanata, ceramica delicata, vetro, marmura si granit</b>		
BM2008306	<b>CPF180</b> Ø 180 mm, grosime 2 mm, prindere 30/25,4 mm	69,5
BMCPF200	<b>CPF220</b> Ø 200 mm, grosime 2 mm, prindere 30/25,4 mm	78,9
8023743009507	<b>CPF250</b> Ø 250 mm, grosime 2 mm, prindere 30/25,4 mm	115
8023743009521	<b>CPF350</b> Ø 350 mm, grosime 2,2 mm, prindere 30/25,4 mm	177

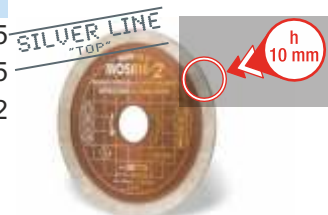
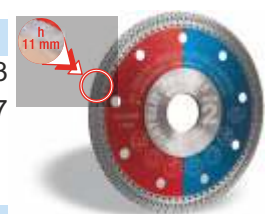

Cod produs	Descriere produs	Pret Euro (fara TVA)
<b>Disc XAMURAY CPH pentru ceramica/gresie portelenata/marmur/granit</b>		
8023743018936	<b>CPH180</b> Ø 180 mm, grosime 1,6 mm, prindere 25,4/22,2 mm	58,9
8023743018929	<b>CPH200</b> Ø 200 mm, grosime 1,6 mm, prindere 30/25,4 mm	69,4
BMCPH230	<b>CPH230</b> Ø 230 mm, grosime 1,6 mm, prindere 30/25,4 mm	102
8023743018998	<b>CPH250</b> Ø 250 mm, grosime 1,65 mm, prindere 30/25,4 mm	106
8023743019001	<b>CPH300</b> Ø 300 mm, grosime 2,0 mm, prindere 30/25,4 mm	129
8023743019018	<b>CPH350</b> Ø 350 mm, grosime 2,2 mm, prindere 30/25,4 mm	167
<b>Disc TBH pentru taiere beton/granit/gresie portelanata</b>		
8023743007114	<b>TBH180</b> Ø 180 mm, grosime 2,4 mm, prindere 22,2 mm	59,7
8023743007121	<b>TBH200</b> Ø 200 mm, grosime 2,4 mm, prindere 30/25,4 mm	63,7
8023743007138	<b>TBH230P</b> Ø 230 mm, grosime 2,4 mm, prindere 22,2 mm	77,4
<b>Disc LEH universal pentru materiale de constructii si piatra</b>		
8023743012842	<b>LEH230P</b> Ø 230 mm, grosime 2,4 mm, prindere 22,2 mm	61,3
8023743012859	<b>LEH30018</b> Ø 300 mm, grosime 2,8 mm, prindere 30/25,4 mm	112
8023743012866	<b>LEH35021</b> Ø 350 mm, grosime 3,2 mm, prindere 30/25,4 mm	139
<b>Disc LBH diamantat - taiere uscata - pentru beton, granit, piatra dura</b>		
8023743012026	<b>LBH160</b> Ø 160 mm, grosime 2,4 mm, prindere 22,2 mm	82,3
8023743003994	<b>LBH180</b> Ø 180 mm, grosime 2,4 mm, prindere 22,2 mm	78,2
8023743004038	<b>LBH250</b> Ø 250 mm, grosime 2,4 mm, prindere 30/25,4 mm	105
8023743004052	<b>LBH350</b> Ø 350 mm, grosime 2,4 mm, prindere 30/25,4 mm	171
<b>Disc SSD pentru gresie portelenata</b>		
8023743028454	<b>SSD115</b> Ø 115 mm, prindere 22,2 mm	36,3
8023743028461	<b>SSD125</b> Ø 125 mm, prindere 22,2 mm	39,5
<b>Nou!</b>	<b>Disc CZ pentru gresie portelanata si ceramica</b>	
8023743018400	<b>CZ100</b> Ø 100 mm, grosime 22,2/15,8 mm, prindere 1,4 mm	17,8
8023743003765	<b>CZ115</b> Ø 115 mm, grosime 22,2 mm, prindere 1,4 mm	19,4
8023743003772	<b>CZ125</b> Ø 125 mm, grosime 22,2 mm, prindere 1,4 mm	21,0
<b>Nou!</b>	<b>Disc TCS-E pentru gresie portelanata si ceramica</b>	
8023743018356	<b>TCS100E</b> Ø 100mm, prindere 22,2/15,8 mm, grosime 1,4 mm	21,0
8023743006742	<b>TCS115E</b> Ø 115 mm, prindere 22,2 mm, grosime 1,4 mm	21,8
8023743019124	<b>TCS125E</b> Ø 125 mm, prindere 22,2 mm, grosime 1,4 mm	22,6
<b>Nou!</b>	<b>Disc TZ pentru pentru materiale de constructii</b>	
8023743001976	<b>TZ115</b> Ø 115 mm, grosime 2,0 mm, prindere 22,2 mm	20,2
8023743002065	<b>TZ230P</b> Ø 230 mm, grosime 2,6 mm, prindere 22,2 mm	41,1
<b>SAFE DIAMOND BOX</b>		
8023743025484	Cutie accesorii diamantate Montolit	47,3

Cod produs

Descriere produs

Pret Euro (fara TVA)

**Perforari in: gresie portelanata, ceramica, granit, marmura, mozaic**

BMFPUS6     h max  
M14 35mm  
FPUS6 Freza speciala pentru modelari speciale, 6 mm







58

BM0005965     h max  
M14 50mm  
FPU20 Freza speciala pentru modelari speciale, 20 mm

84,4





**Perforari in: gresie portelanata, ceramica, granit, marmura, mozaic**

BMFPS35     h max  
5 - 35mm 50mm  
FPS35 Freza speciala pentru modelaj conica, 5 - 35 mm



97,7



8023743021981     h max  
35 - 75mm 50mm  
FPS75 Freza speciala pentru modelaj conica, 35 - 75 mm

180

**Disc taiere / polizare gresie portelanata, granit, piatra, beton**

BM0005964 **STL125GG-M** Disc 125 mm prindere 22,2 mm

100



**Disc FLEXIMONT lamelar diamantat**

8023743026092 **FLEXIMONTGF** granulatie fina, Ø 115 mm, prindere 22,2 mm



58,1

8023743026115 **FLEXIMONTGG** granulatie grosiera, Ø 115 mm, prindere 22,2 mm

60,5

8023743026108 **FLEXIMONTGM** granulatie medie, Ø 115 mm, prindere 22,2 mm

59,1



**Nou!**



**Disc finisare gresie pentru rotunjire margini**

BM0003894 **FPB10** Profil B, raza 10 mm

184



8023743011104 **DT200** Slefuitor manual Montolit finisare extra fin margine gresie, gr.200

20,5

8023743011098 **DT060** Slefuitor manual Montolit finisare medie margine gresie, gr.60

27,5

**Nou!**

**TRITONE** - Disc de șlefuit diamantat pentru lustruire, potrivit atât pentru utilizarea uscată cât și umedă, cu polizoare unghiulare. Ideal pentru netezire beton, marmură, granit, piatră, plăci de porțelan și pentru îndepărtarea adezivului și a epoxidului.



8023743029406 **TRITONE125**, Ø 125 mm, prindere 22,2 mm

124

## REPREZENTANȚI VÂNZĂRI DISTRIBUȚIE

### Zona Nord-Vest

Adrian Șerban  
0759.032.235  
adrian.serban@italiastar.ro

### Zona Nord-Est

Robert Amolioaiei  
0743.616.118  
robert.a@italiastar.ro

### Zona Vest

Bogdan Rusan  
0759.207.471  
bogdan.rusan@italiastar.ro

### Zona Sud-Vest

Catalin Musat  
0756.180.620  
catalin.musat@italiastar.ro

### Zona Sud-Est

Paul Istrate  
0744.340.500  
paul.istrate@italiastar.ro



### Director Național Vânzări

Gabi Stanciu  
0720.660.774  
gabi.stanciu@italiastar.ro

### Director Suport Vânzări

Mihaela Toma  
0723.274.885  
mihaela.toma@italiastar.ro

## ASISTENȚĂ TEHNICĂ

### ASISTENȚĂ TEHNICĂ SISTEME DE POMPARE

Daniel Cojocaru  
0755.090.529  
servicetm@italiastar.ro

### SERVICE MICA MECANIZARE

Marius Lazăr  
0758.644.374  
service@italiastar.ro

### SERVICE AGRO GARDEN

Razvan Morlova  
0755.090.519  
razvan.morlova@italiastar.ro

### ASISTENȚĂ TEHNICĂ / MENTENANTA

Cosmin Marinescu  
0745.024.593  
cosmin.marinescu@italiastar.ro

## COMENZI / INFO STOC

### SUPPORT VÂNZĂRI

Marius Stoica Alexandru Stoica  
0753.099.671 0749.281.448  
info@italiastar.ro

## DEPOZITE EXTERNALIZATE

### HOPI RO LOGISTICS S.R.L.

Adresa:  
Str. Bradului Nr. 57, Sat Domnești,  
Comuna Dragomirești Vale, Jud. Ilfov

### SLS Cargo

Adresa:  
Str. Italia Nr. 7, Warehouse 0, Chiajna,  
Jud. Ilfov

## ITALIA STAR ACADEMY

### CENTRUL DE TRAINING ȘI FORMARE PROFESIONALĂ

Adresa:  
Autostrada București-Pitești Km. 13,2  
Chiajna, jud. Ilfov

Pentru informații, vă rugăm să  
contactați reprezentantul dvs. zonal

## SEDIU / DEPOZIT / SERVICE

Adresa:  
Autostrada București - Pitești km 13,2,  
Chiajna, Jud. Ilfov - România C.P. 077040  
Coordonate GPS: 44.438989, 25.943253

Telefon: 021.433.03.27  
0756.169.788  
e-mail: info@italiastar.ro  
www.italiastar.ro

